

BIONICLE

# AIRAKA



**WARNING: CHOKING HAZARD.**  
Small parts. Not for children under 3 years.



8904

[WWW.BIONICLE.COM](http://WWW.BIONICLE.COM)



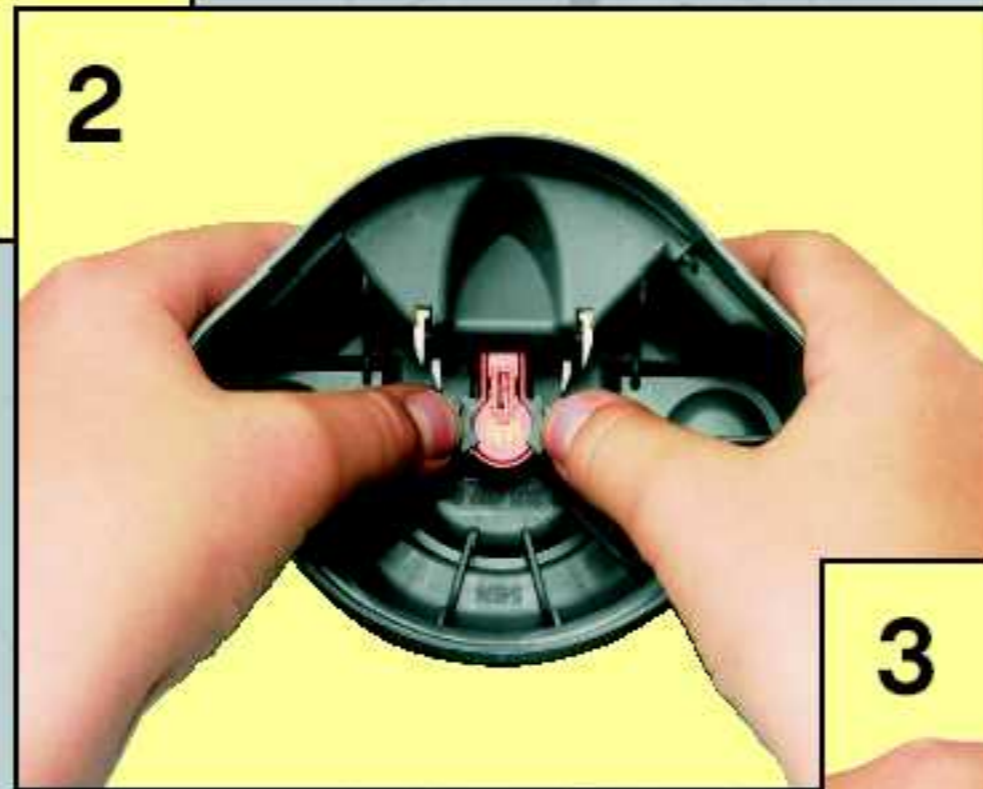
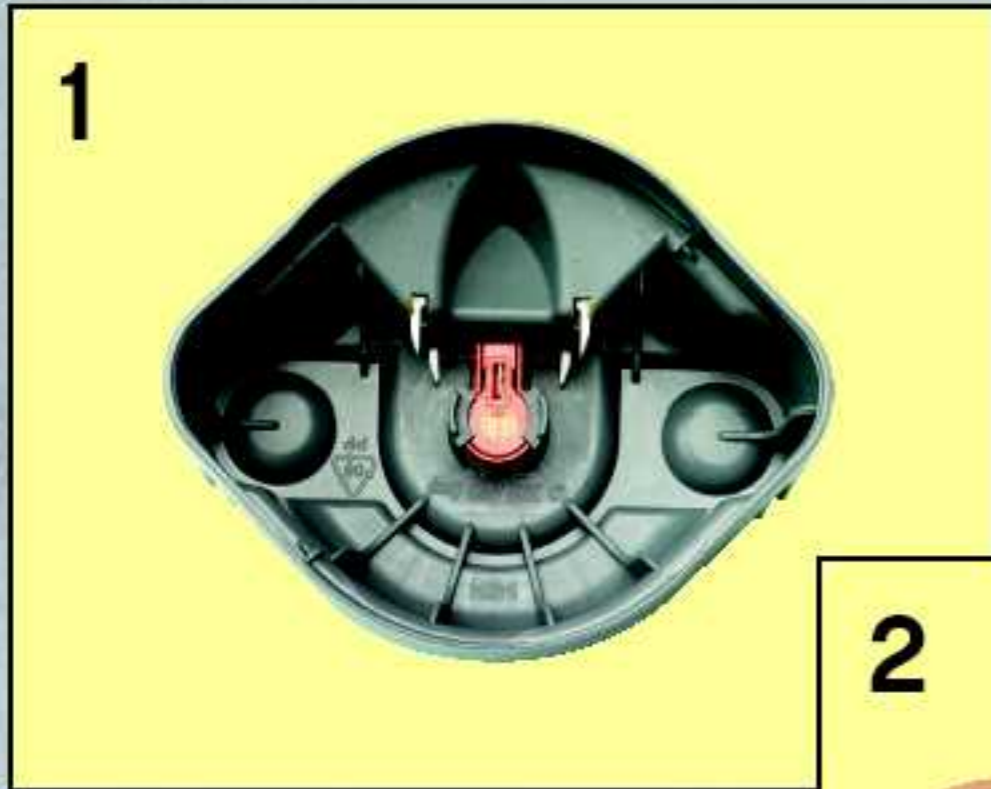

Battery is not replaceable  
La pile n'est pas remplaçable  
La batería no es reemplazable

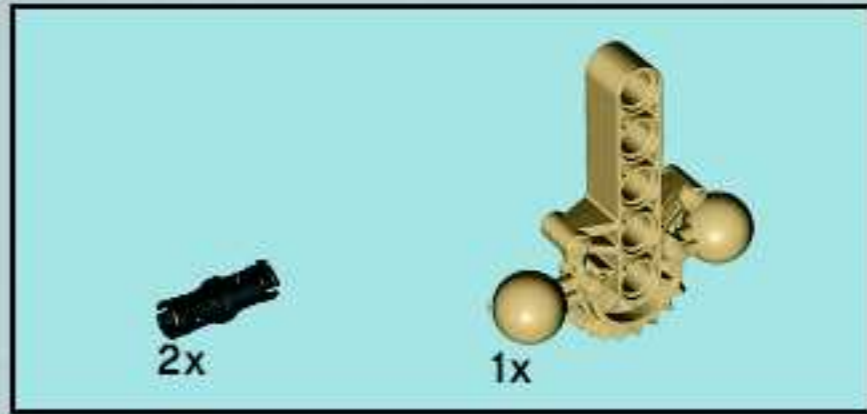

1

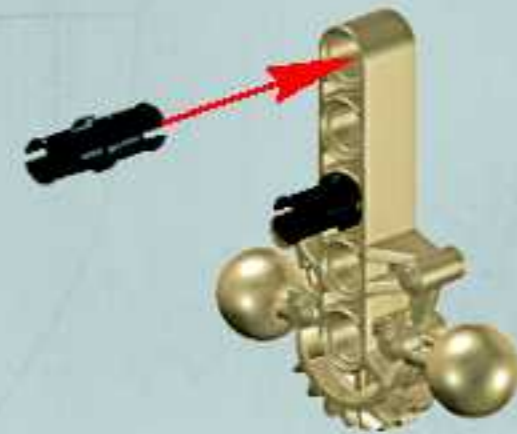

**AVERTISSEMENT : RISQUE D'ÉTOUFFEMENT.**  
Contient des petites pièces. Ne convient pas aux enfants de moins de 3 ans.



**ADVERTENCIA: PELIGRO DE ASFIXIA.**  
No recomendado para niños menores de 3 años. Contiene piezas pequeñas.

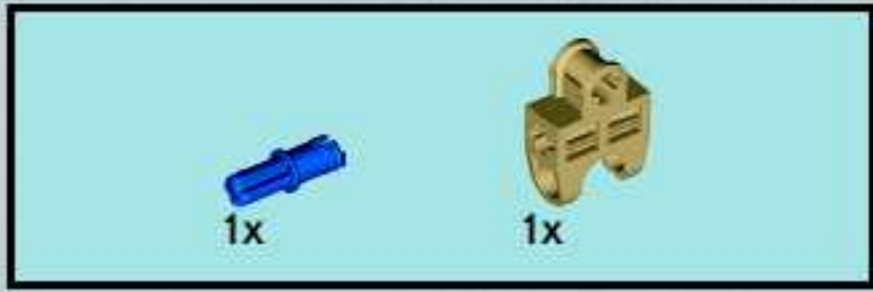
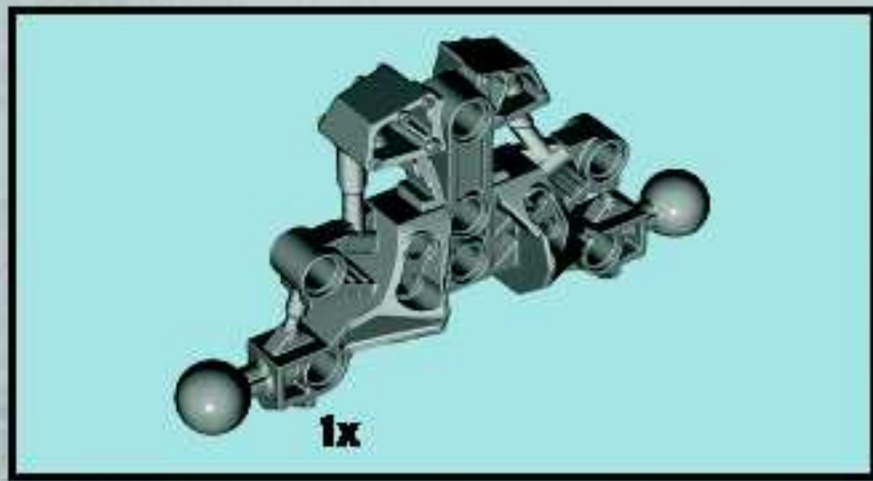

2

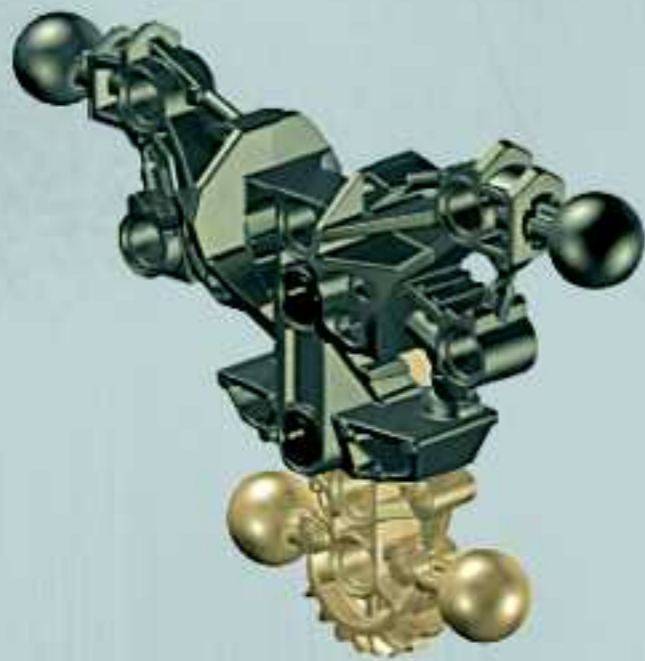

3

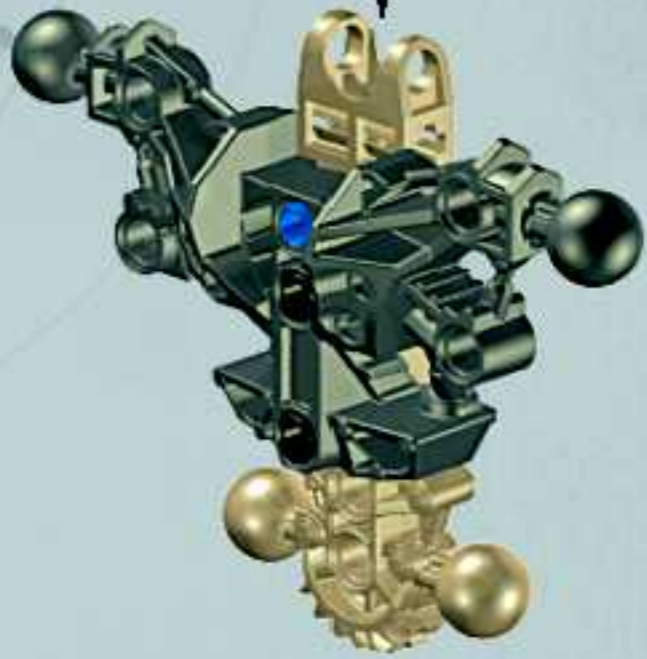
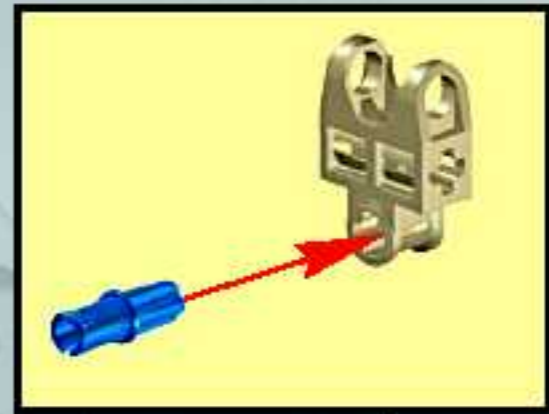

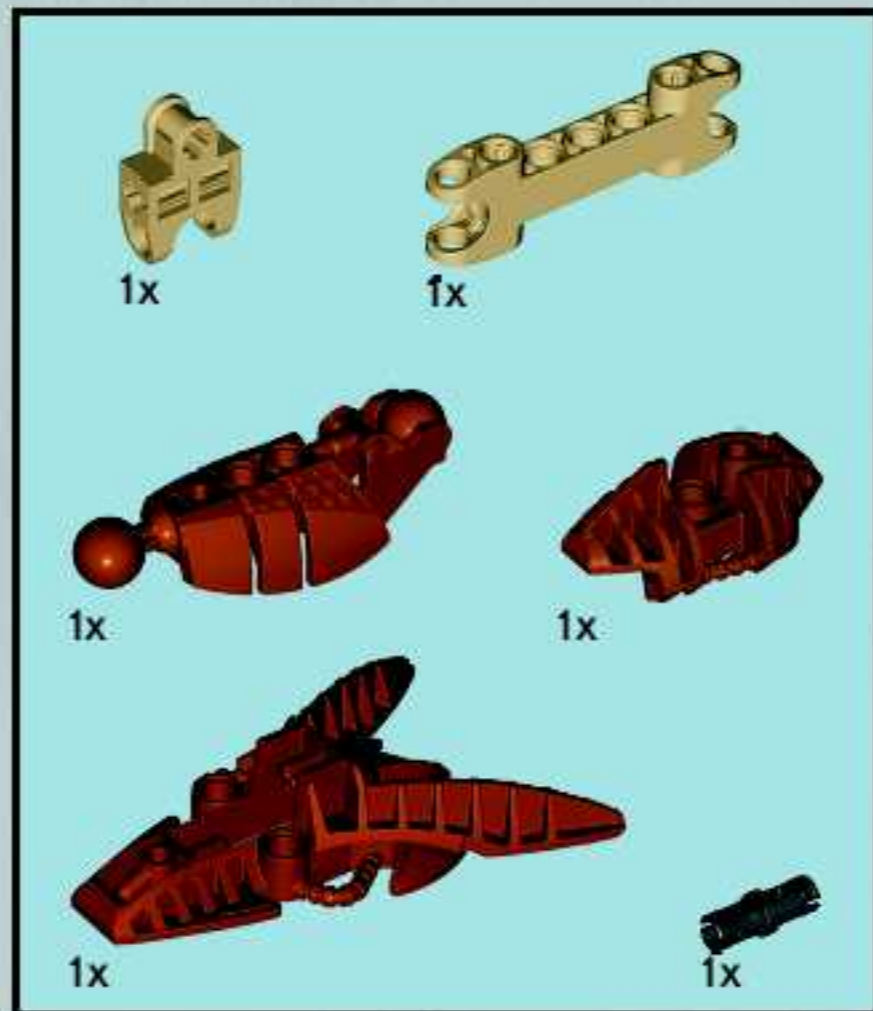

4

1

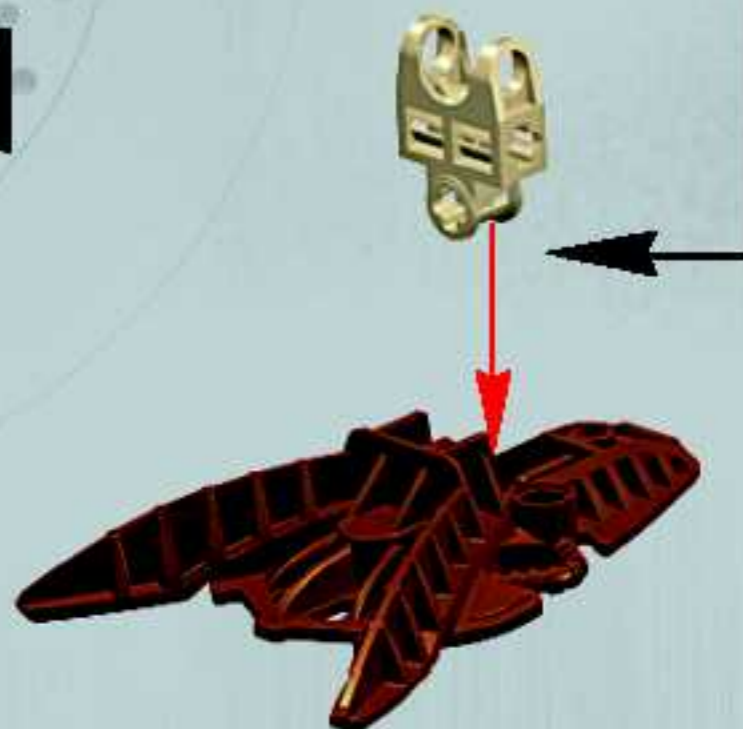
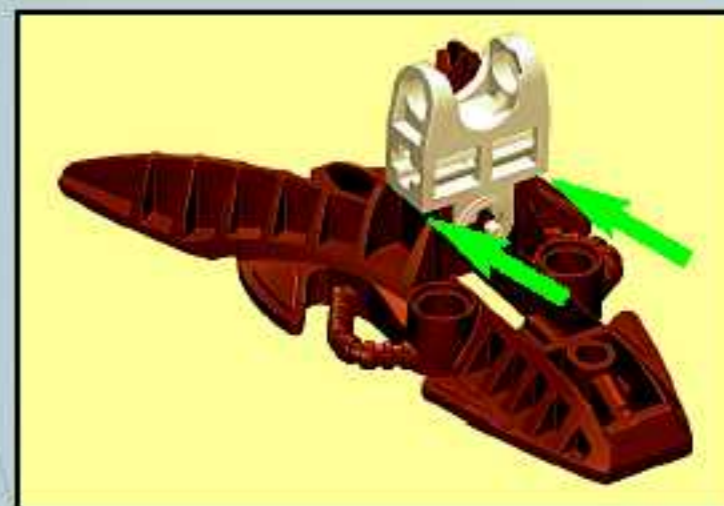

2



3

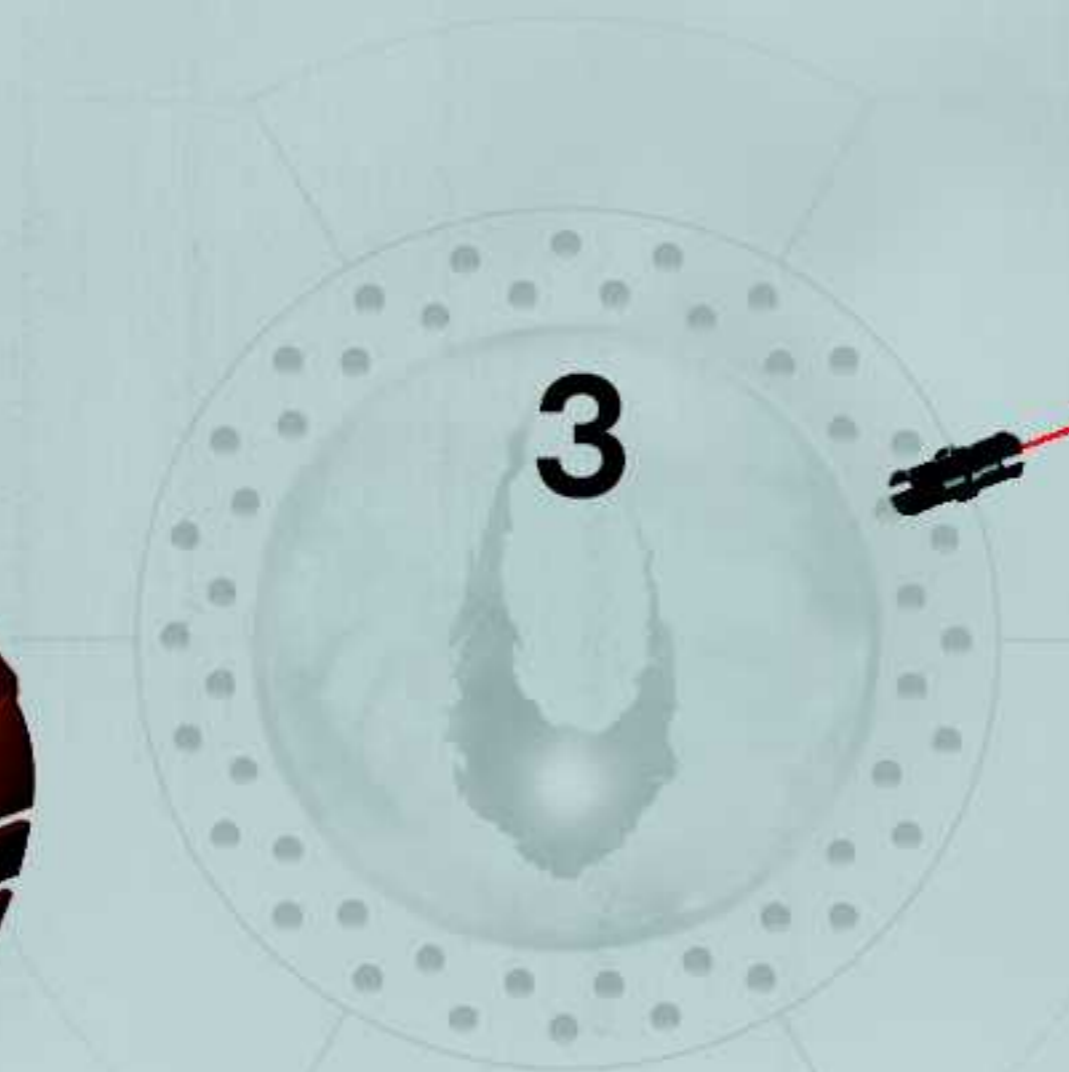

4

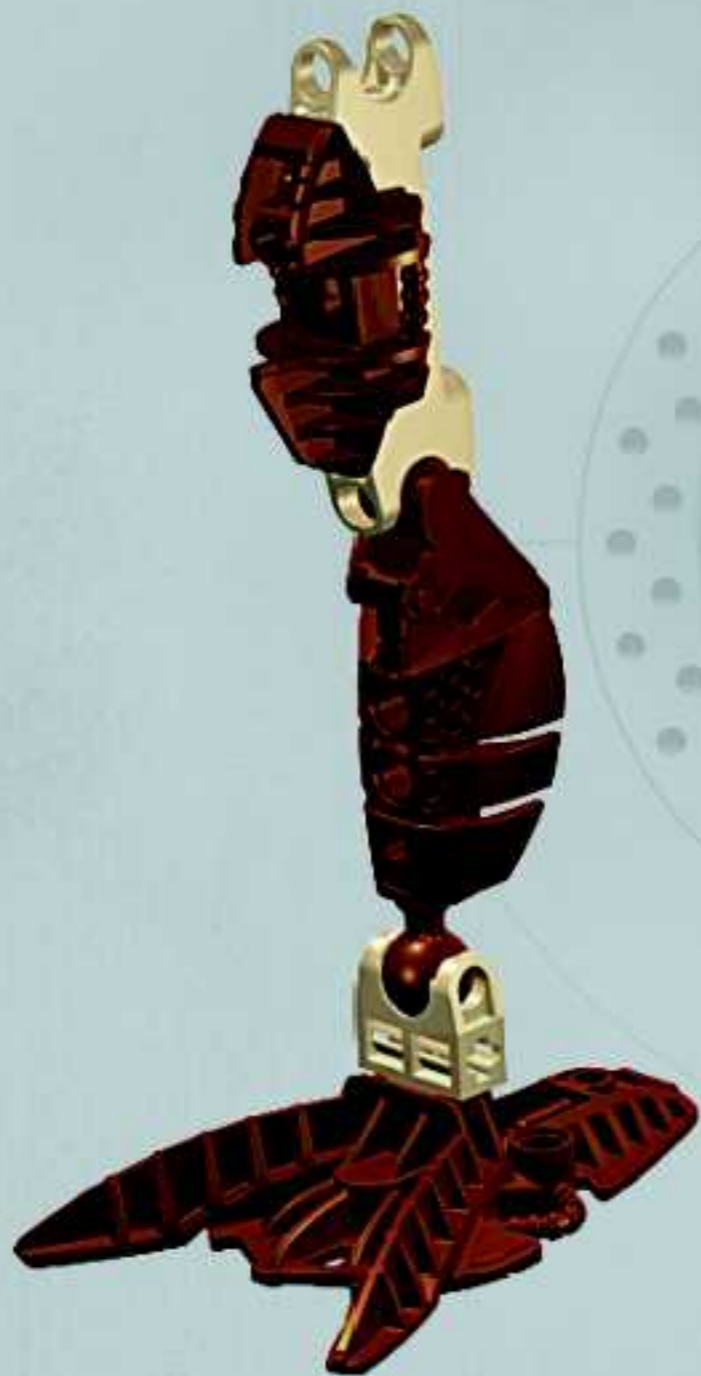

2x

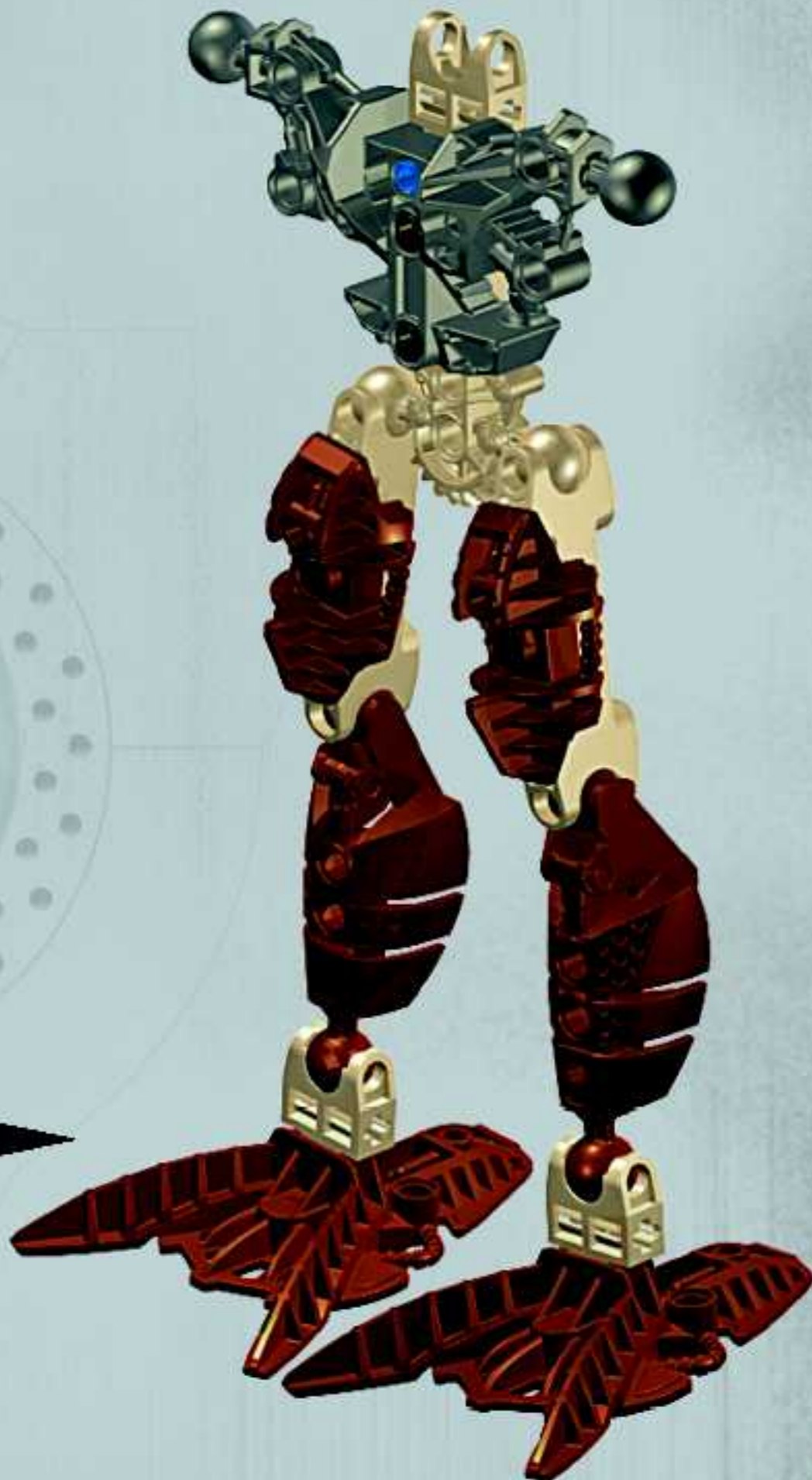

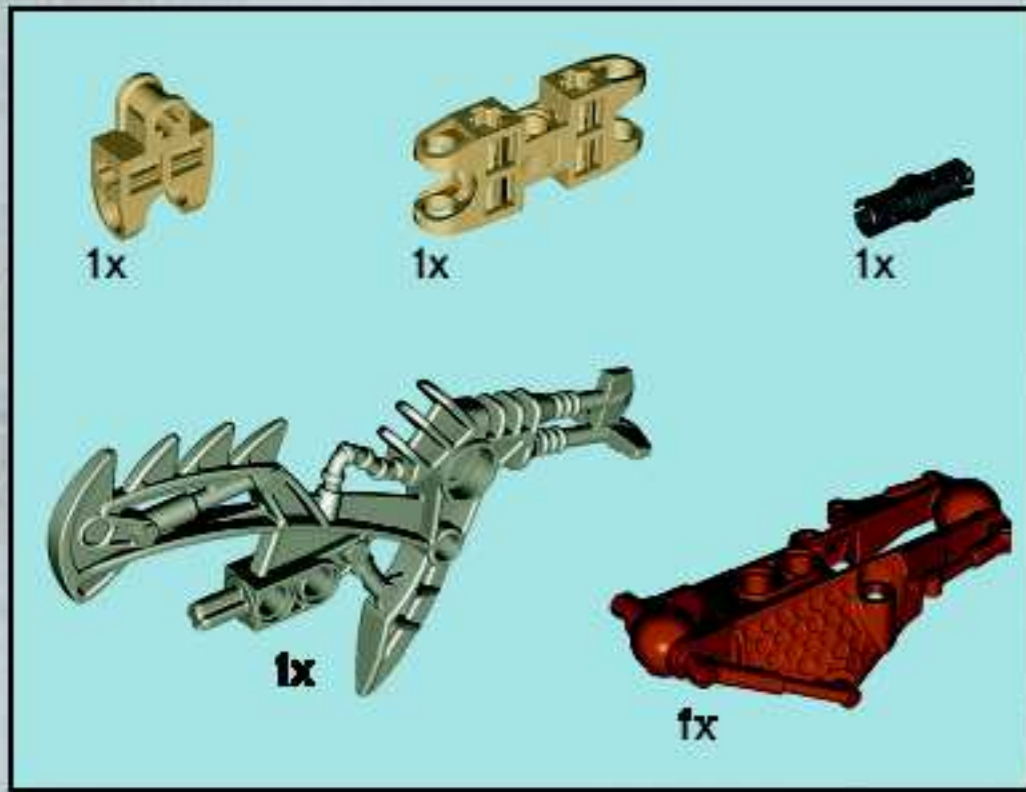

1

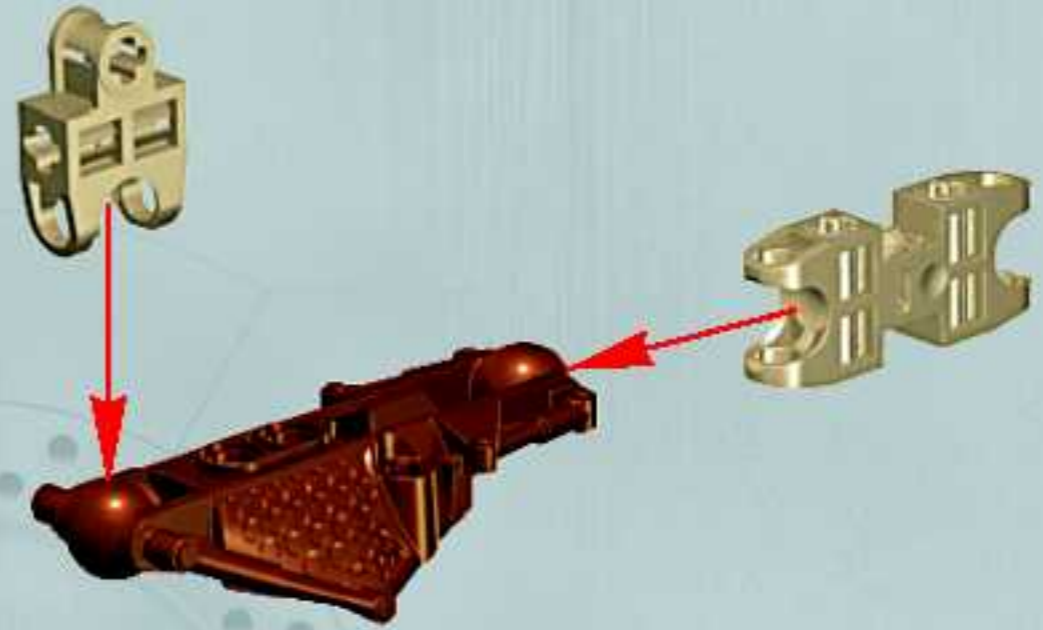

5

2

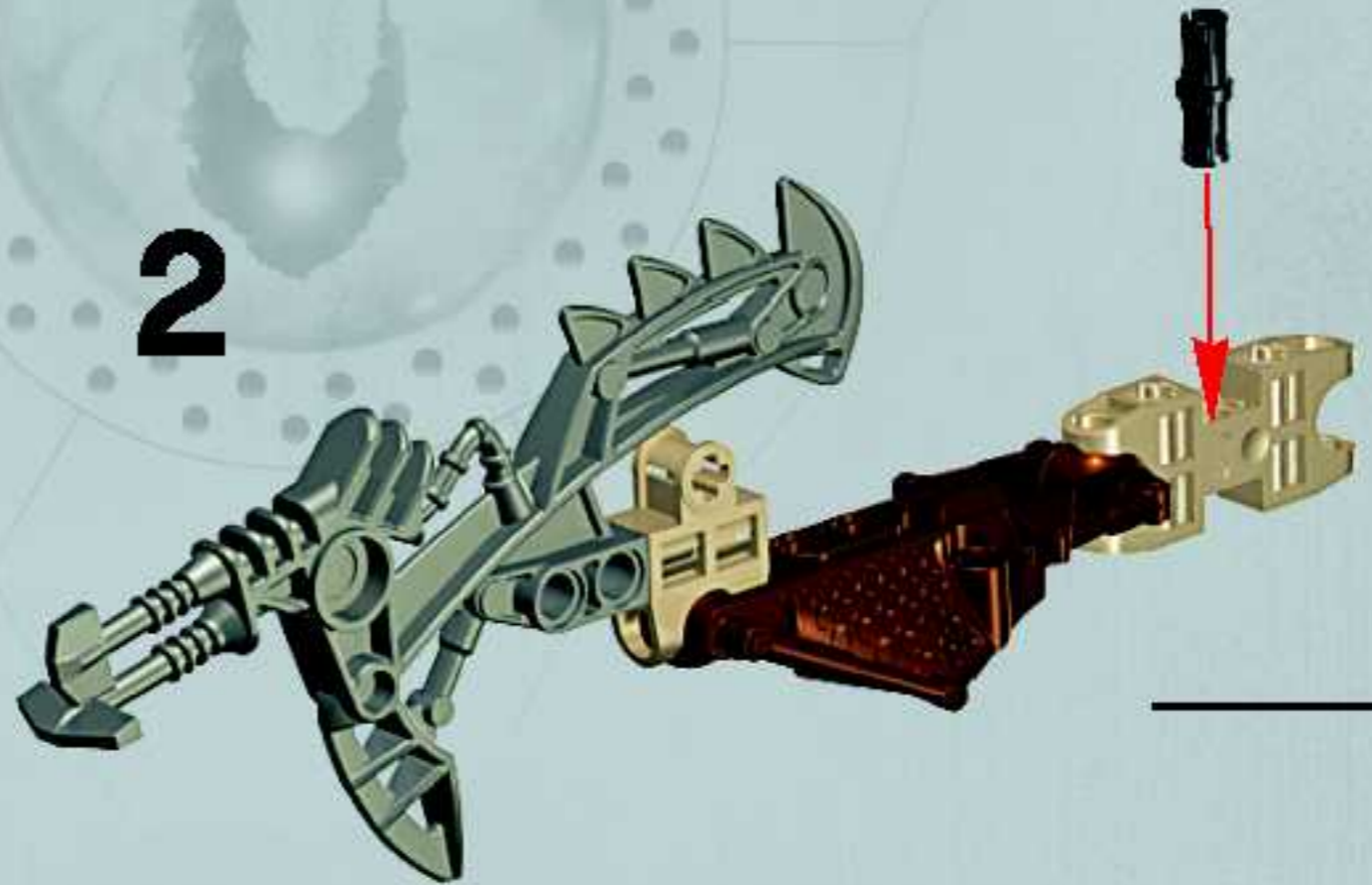



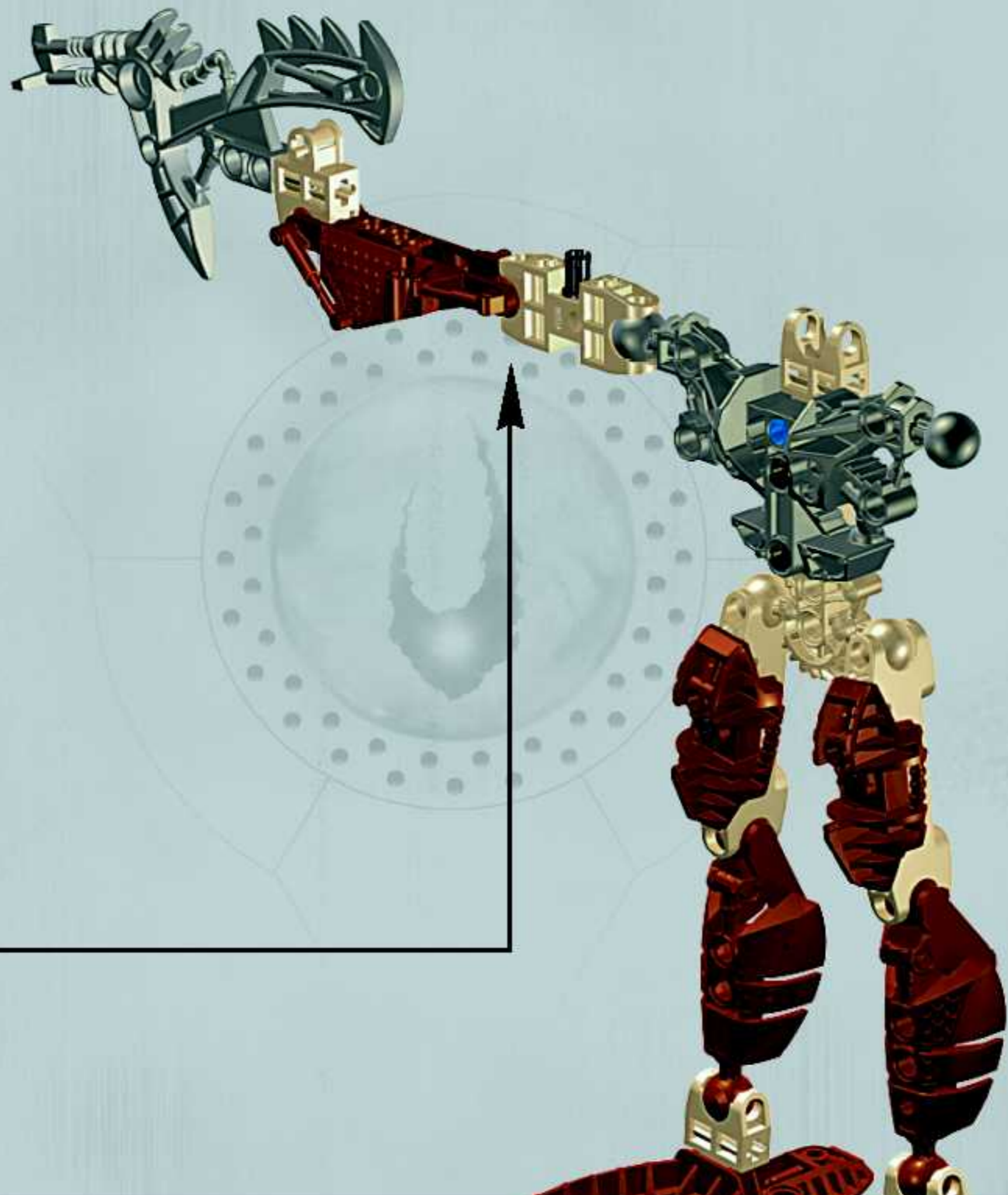

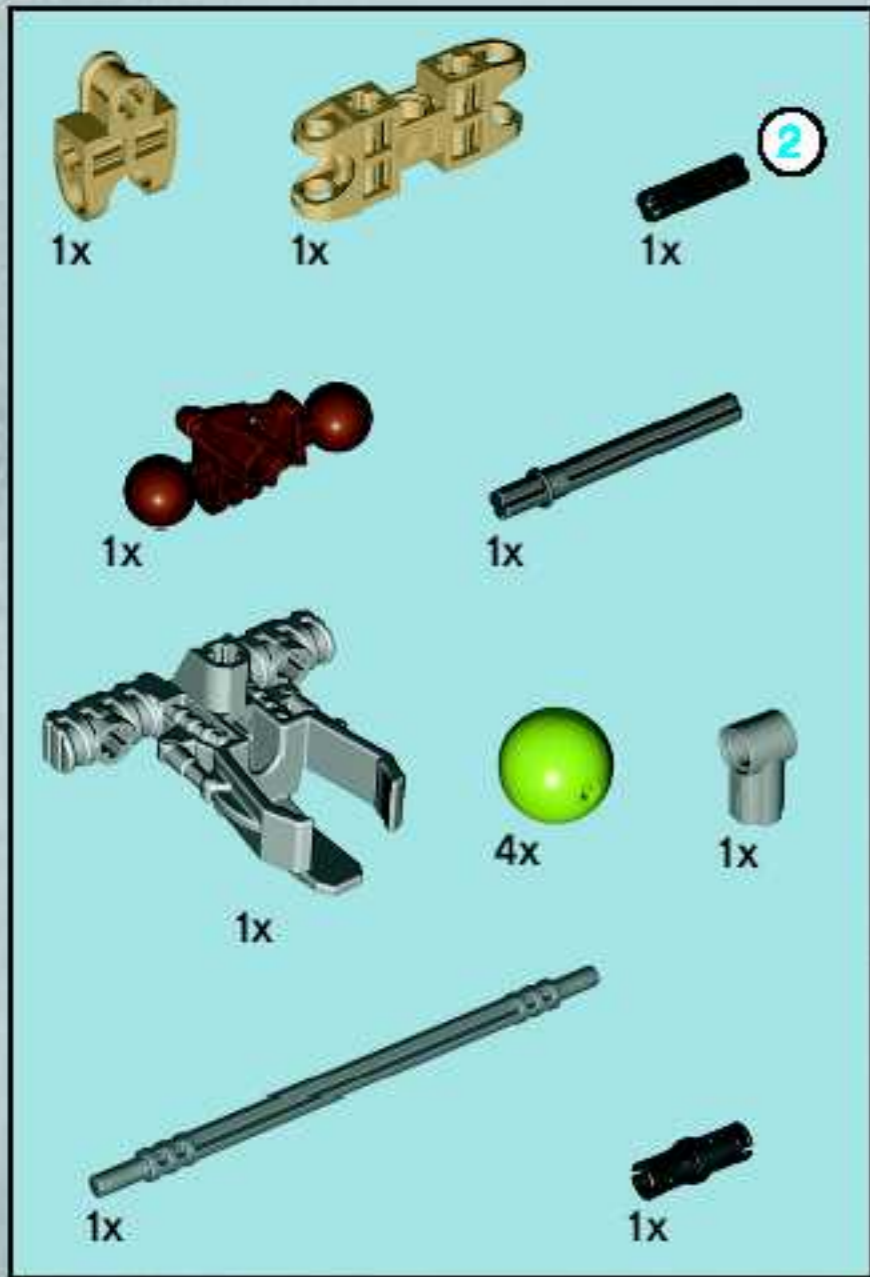

6

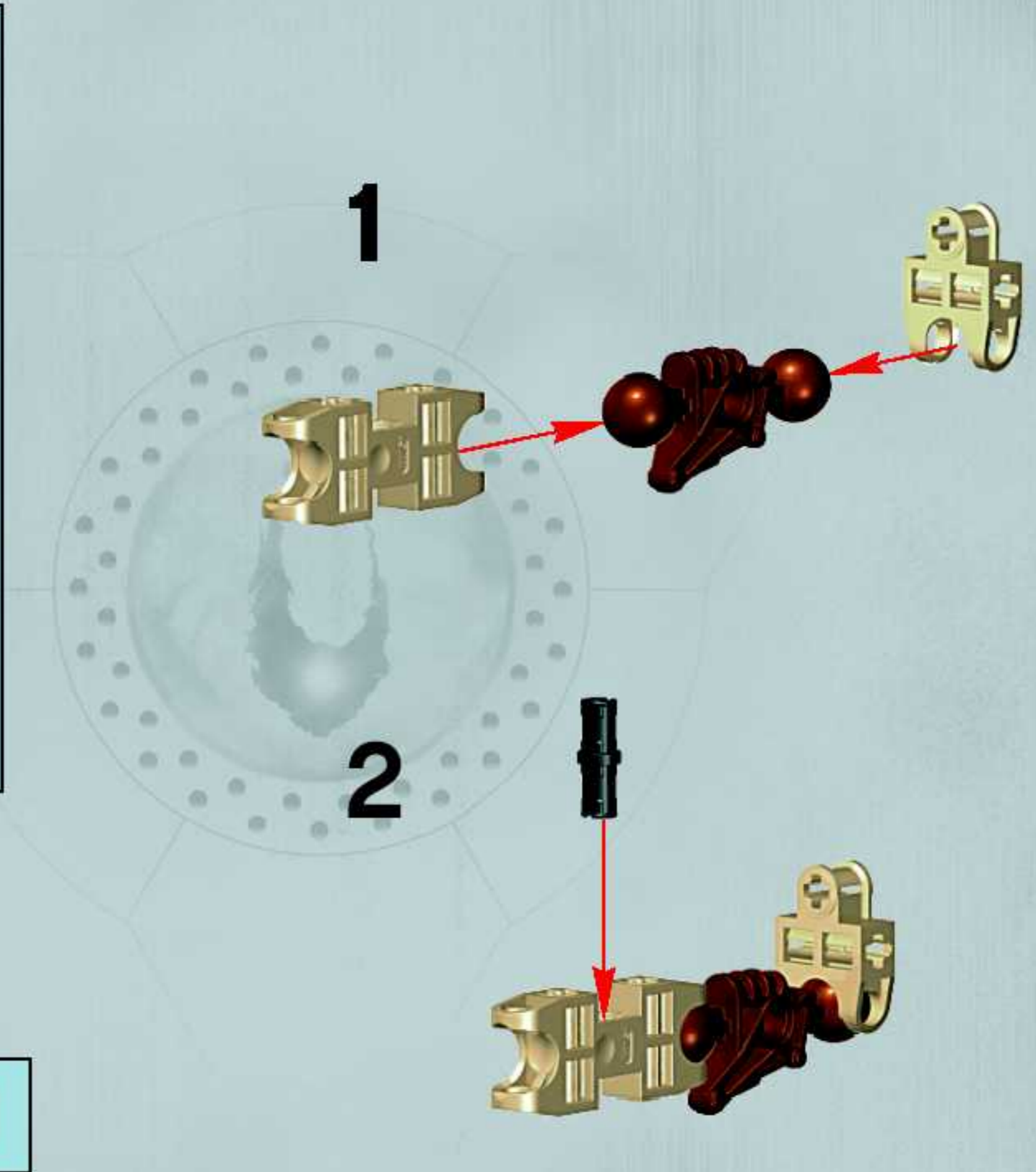
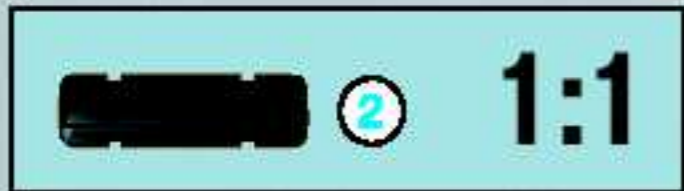

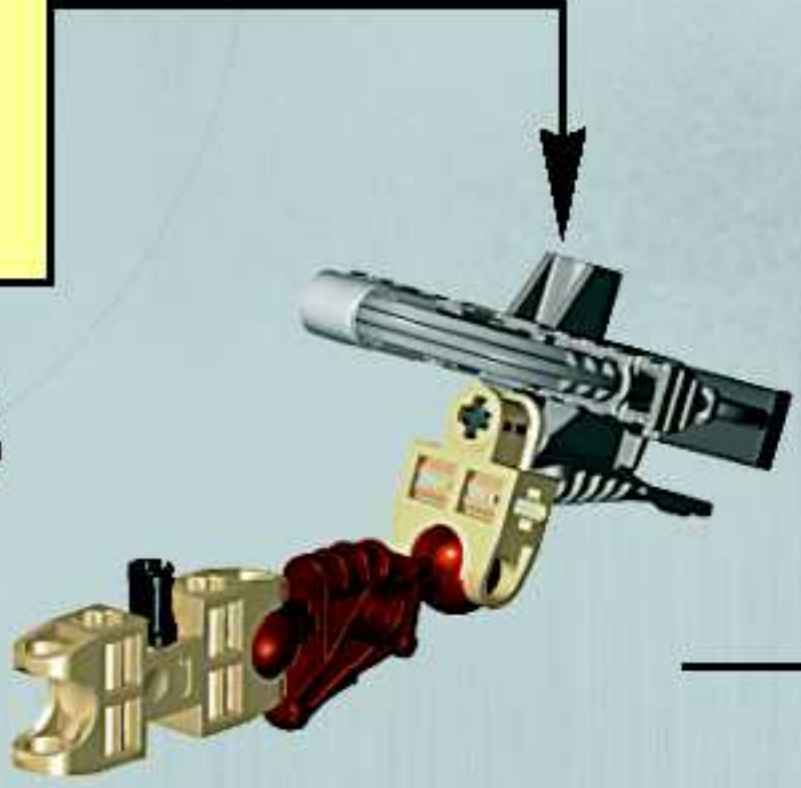
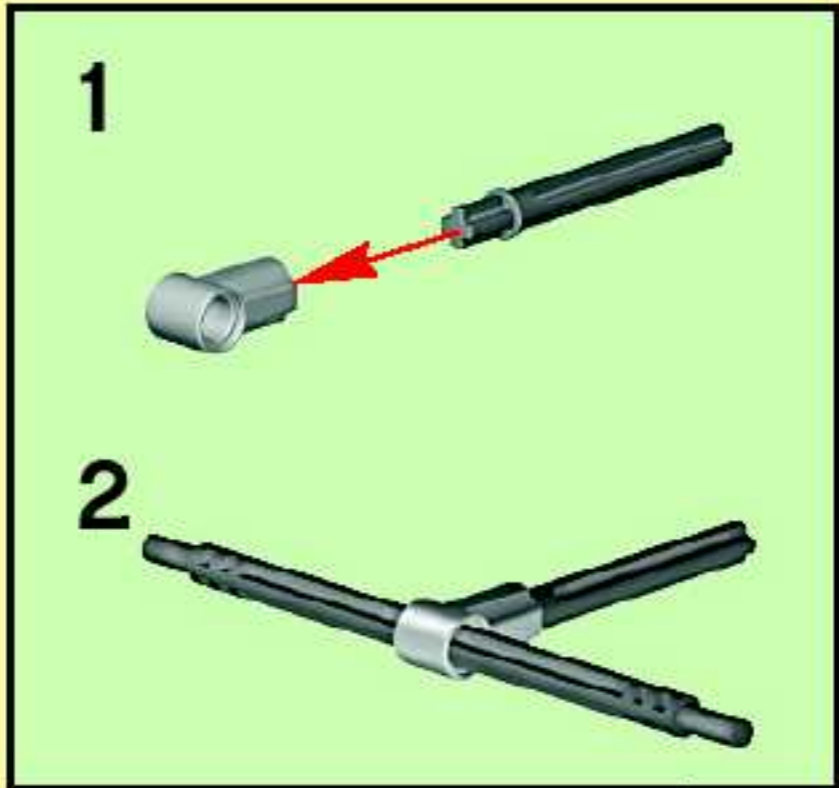
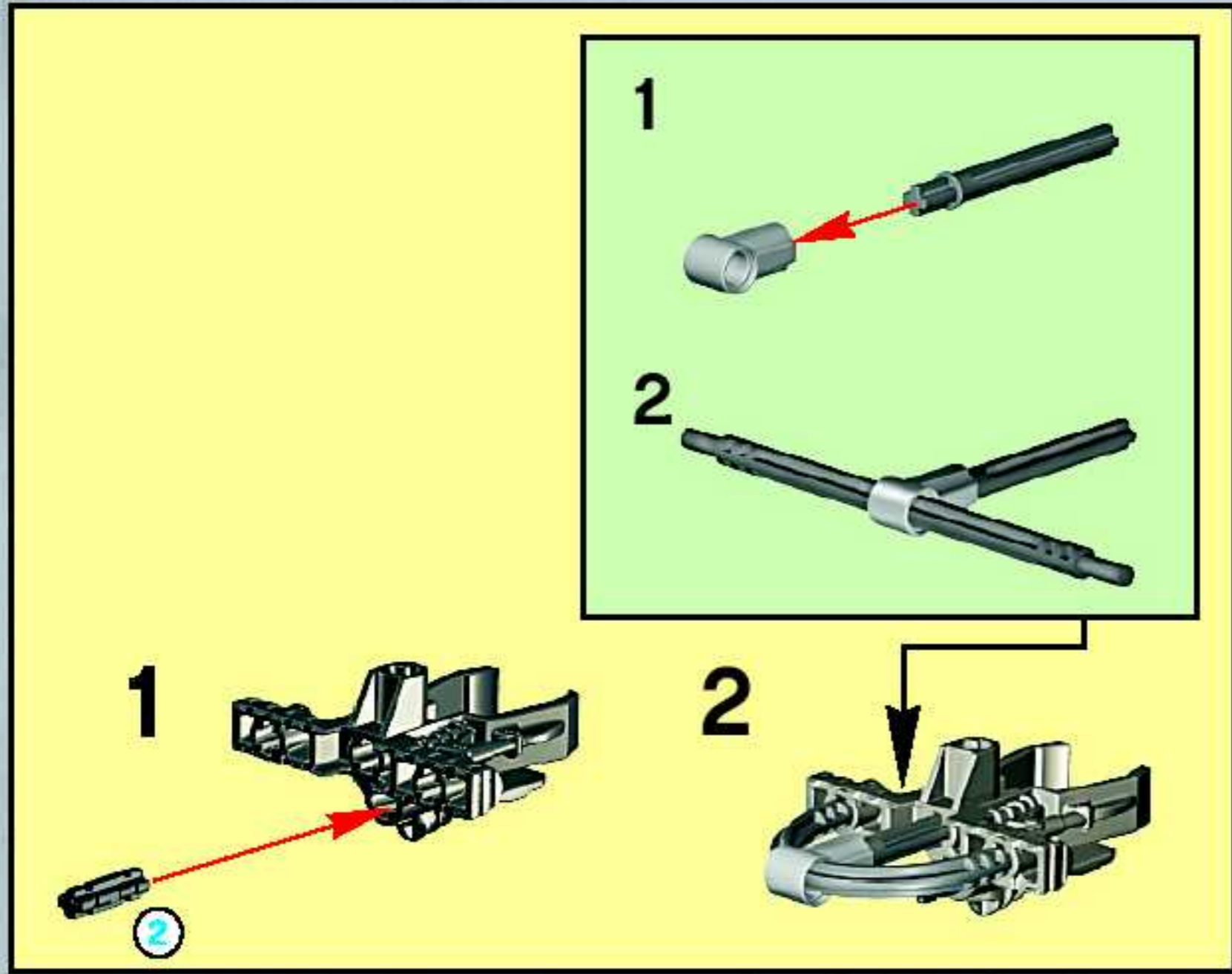

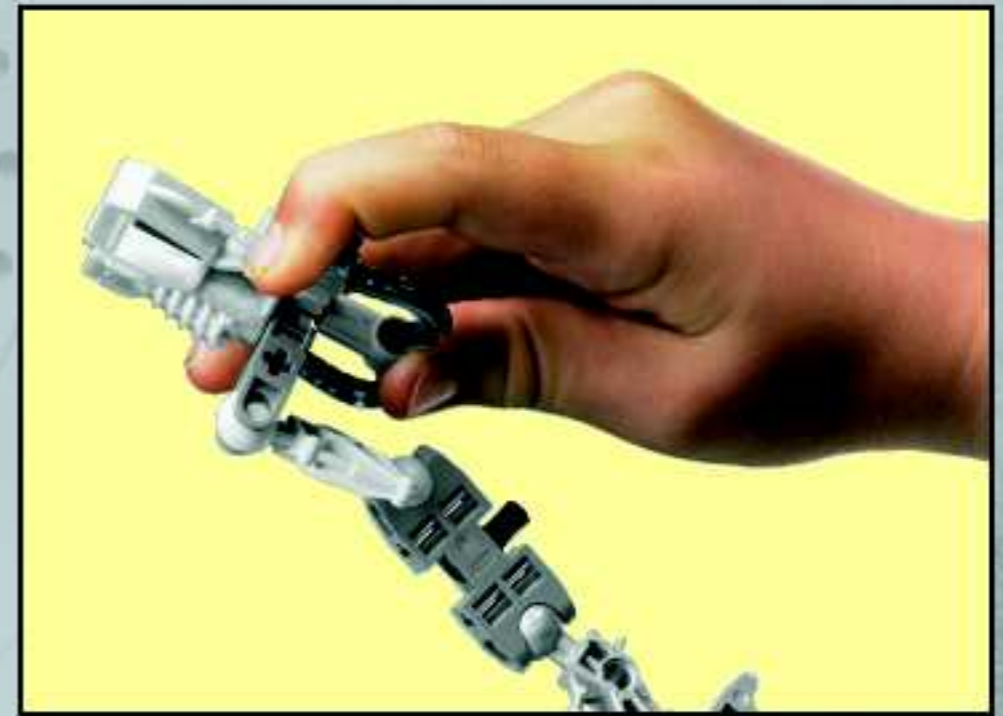
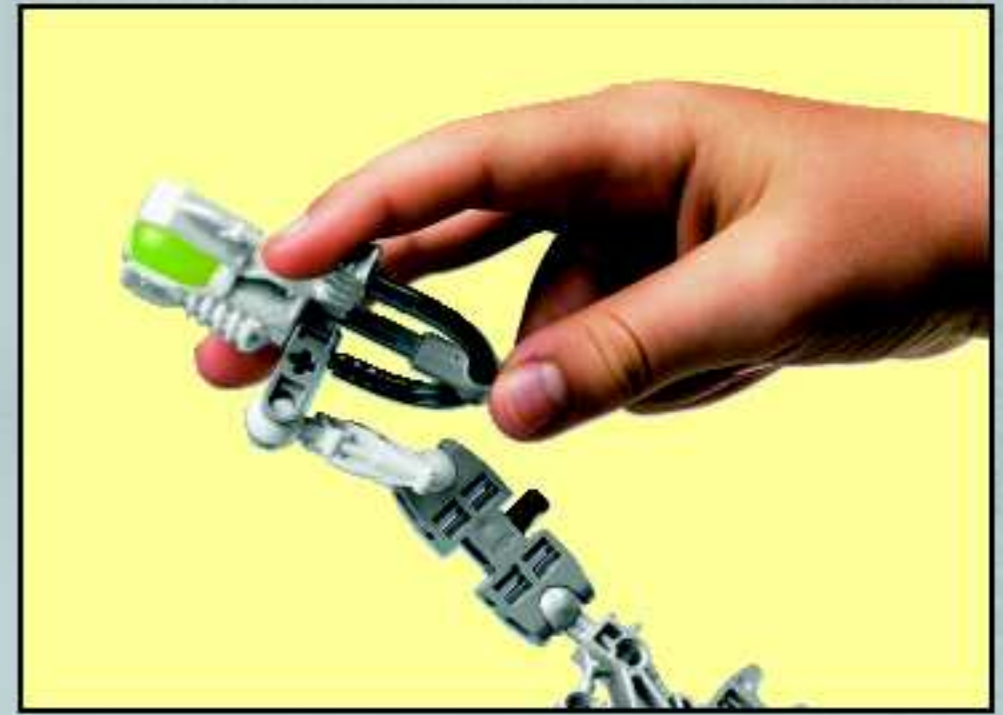
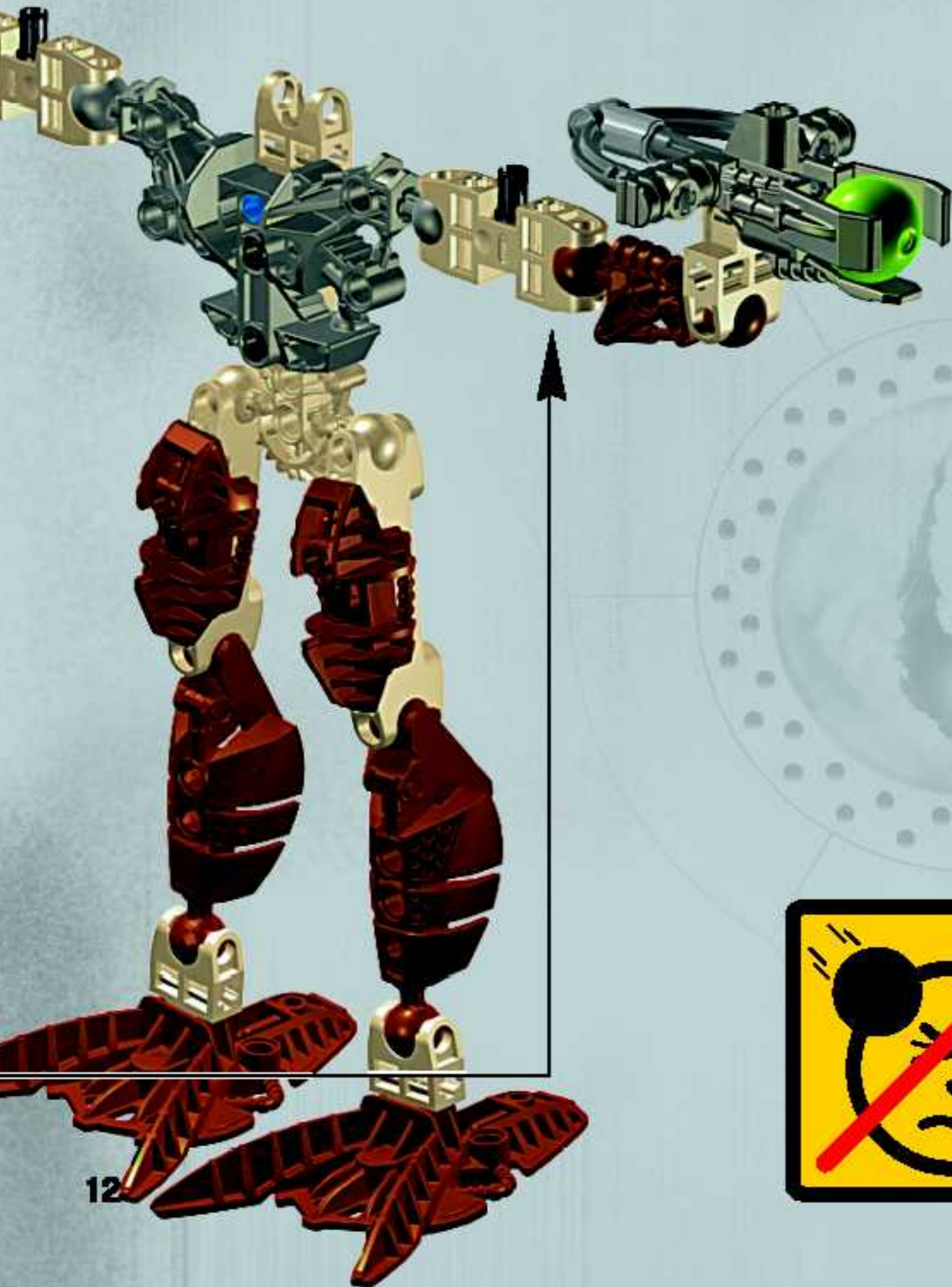

**CAUTION:** Do not aim at eyes or face.  
**ATTENTION :** Ne pas viser les yeux ni le visage.  
**PRECAUCIÓN:** No lo dirija a los ojos o cara.

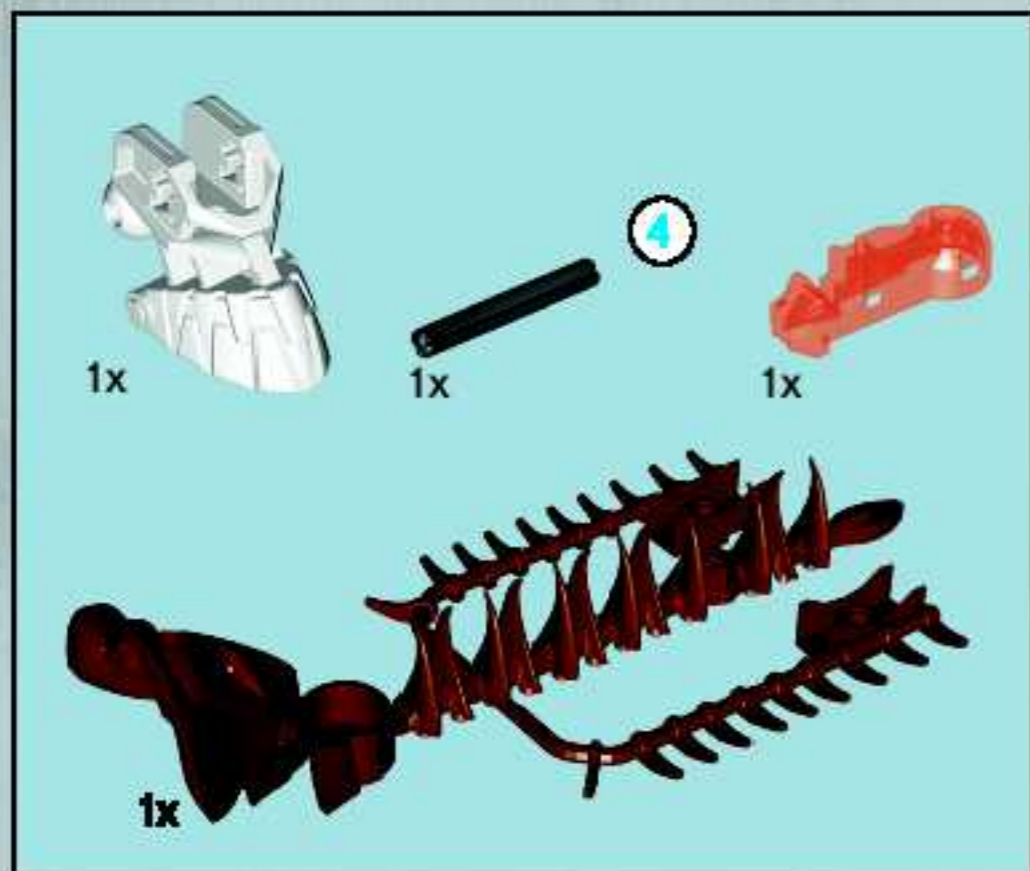

7

1

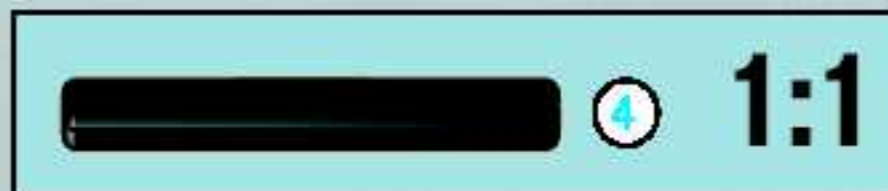
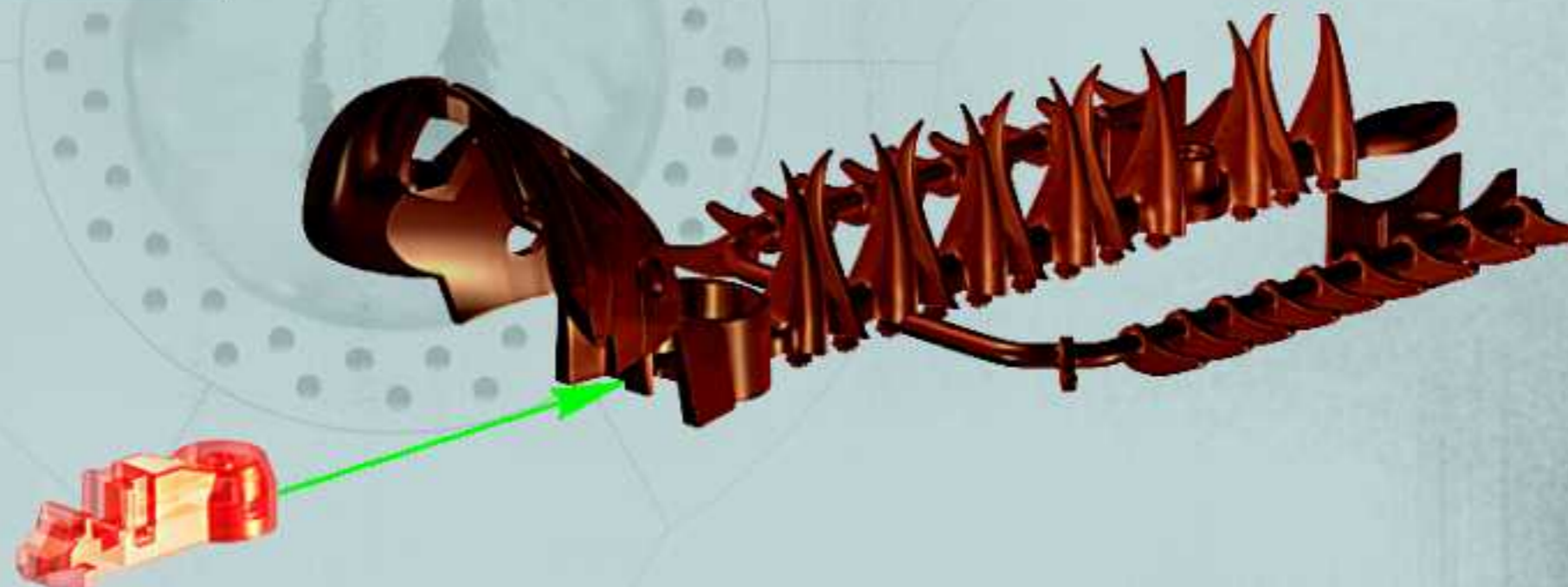

2



3

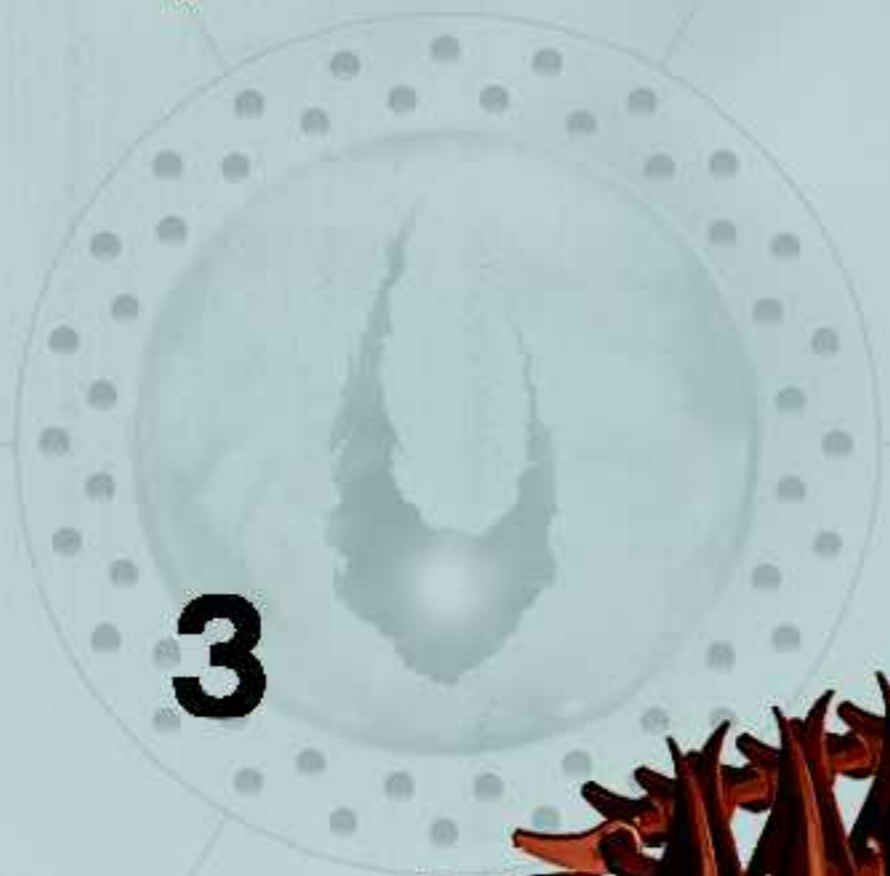

4

**CLICK!**

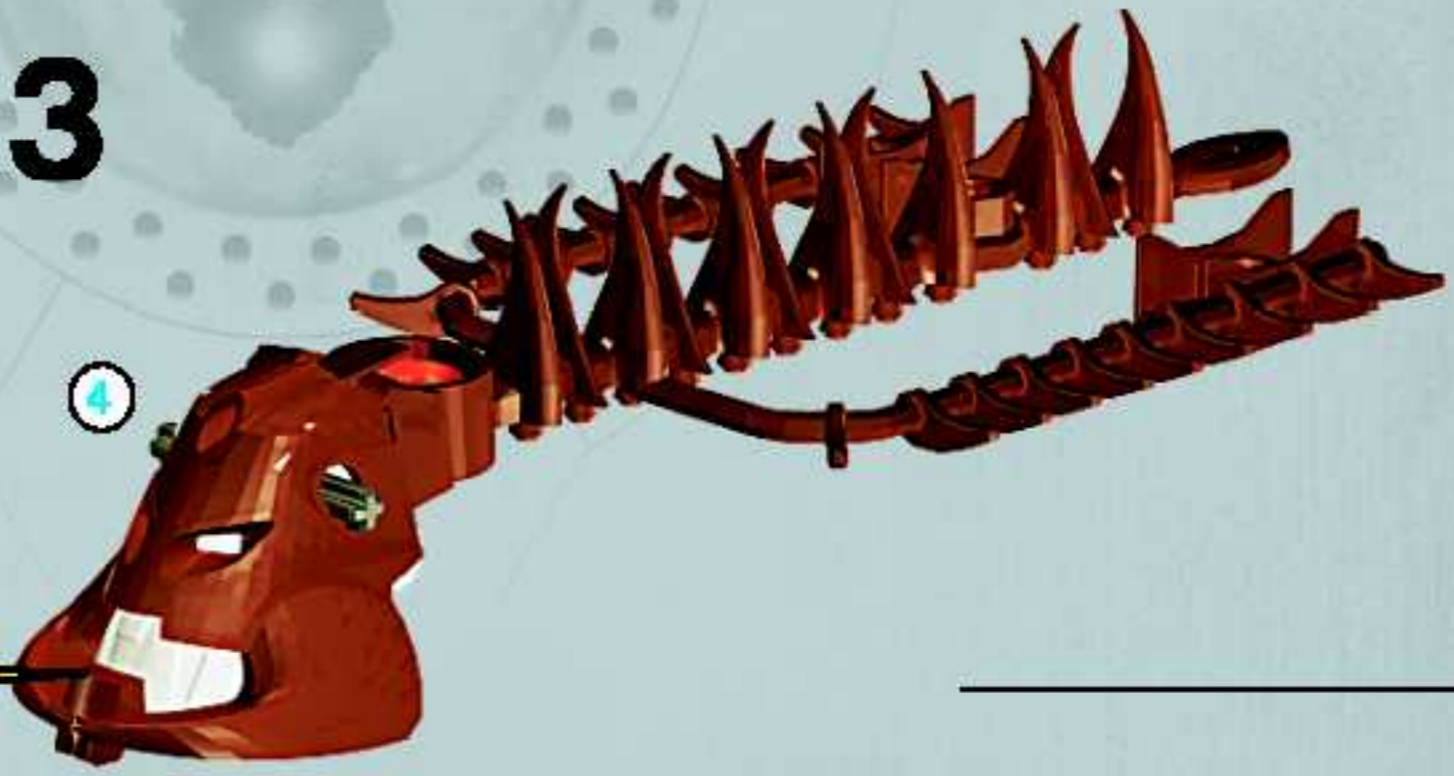

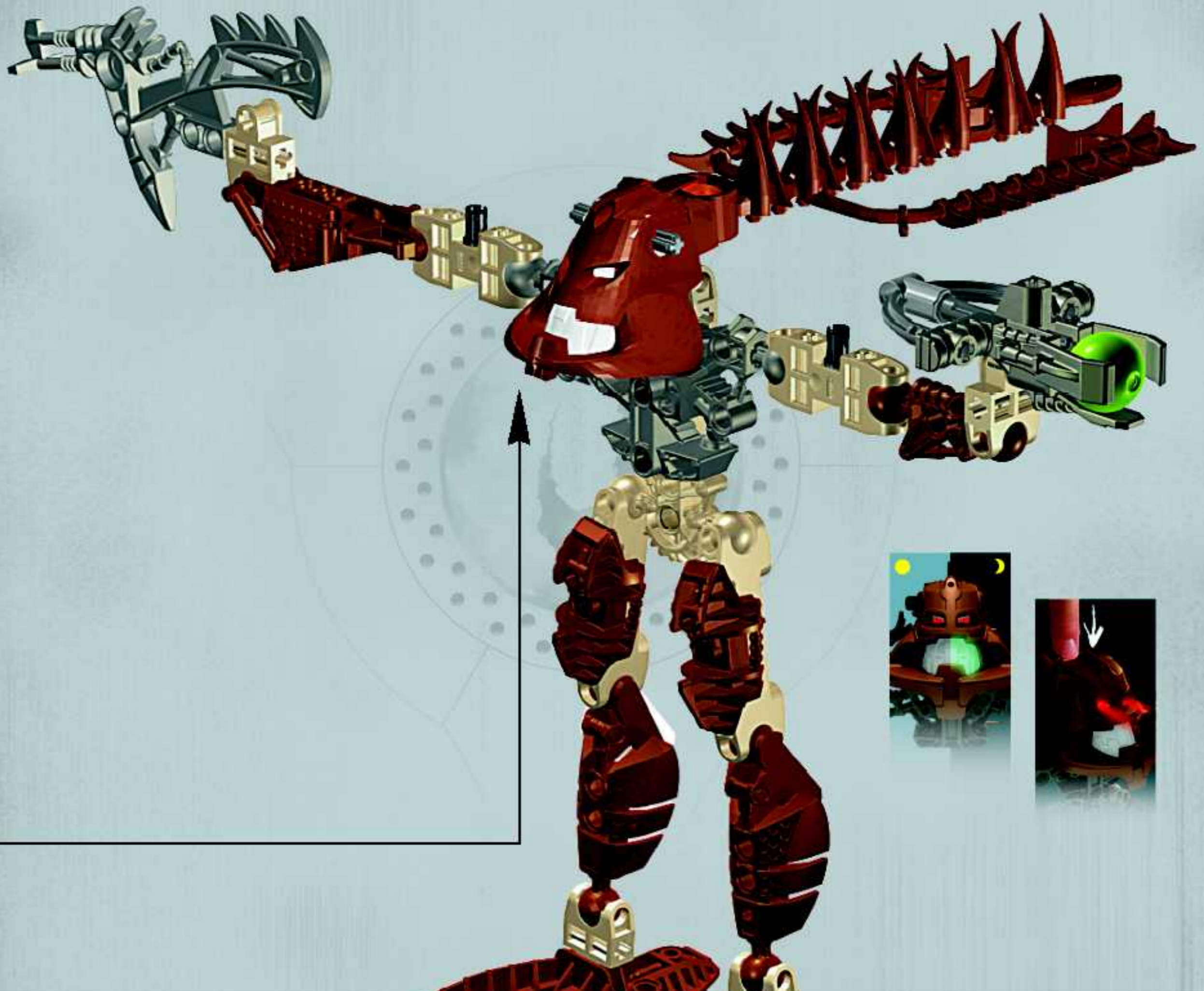



8

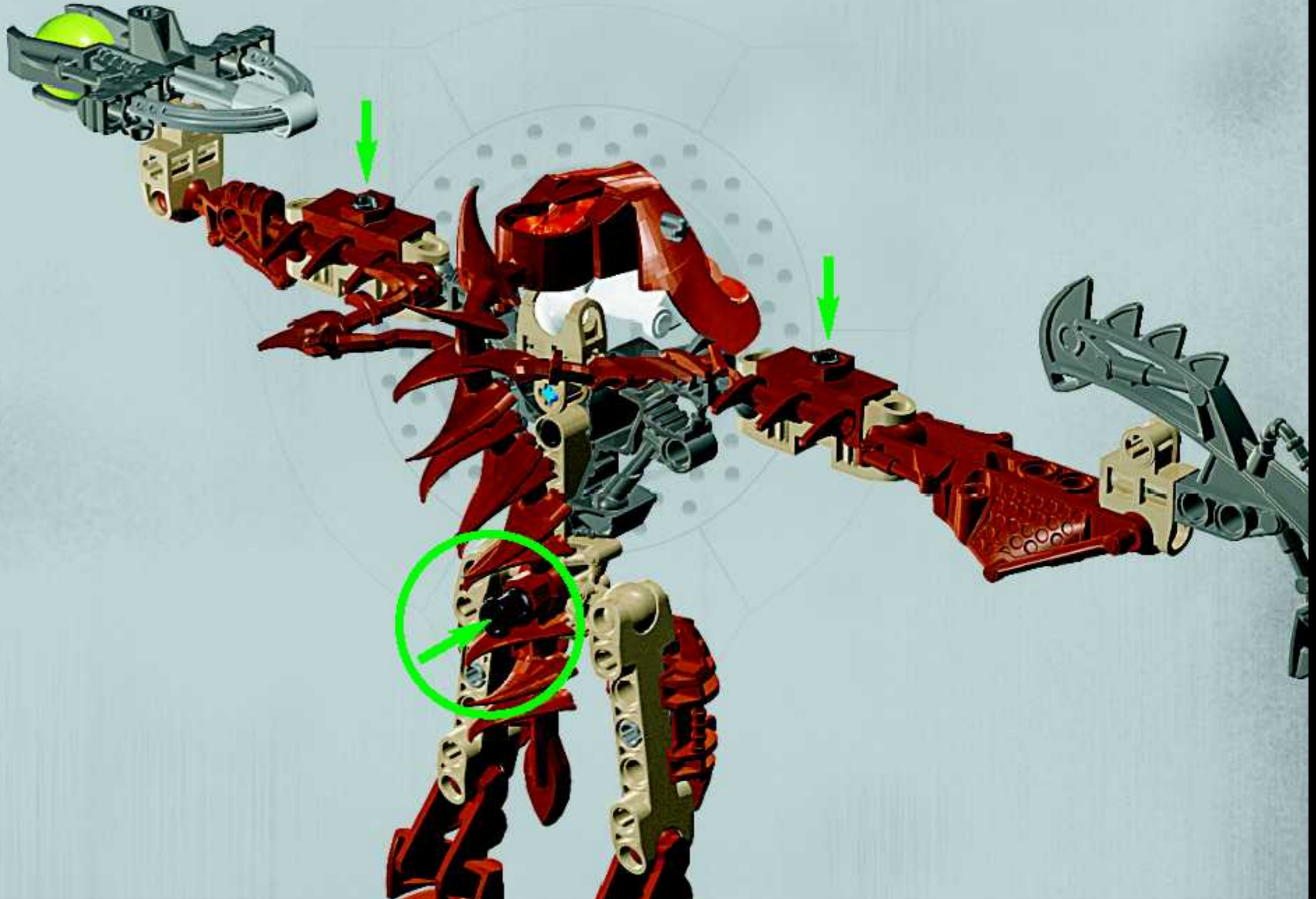



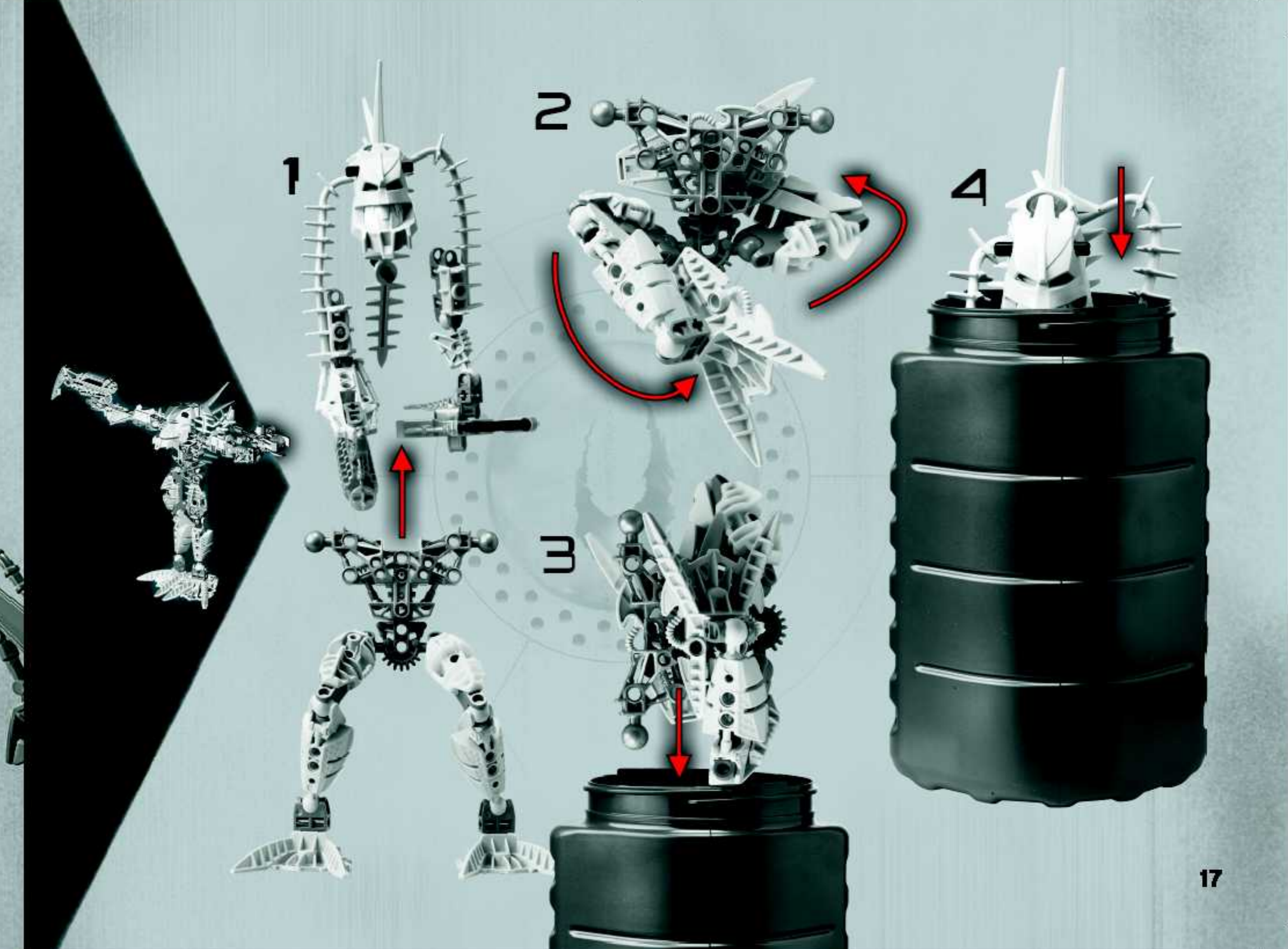

1

2

3

4

8901



8904



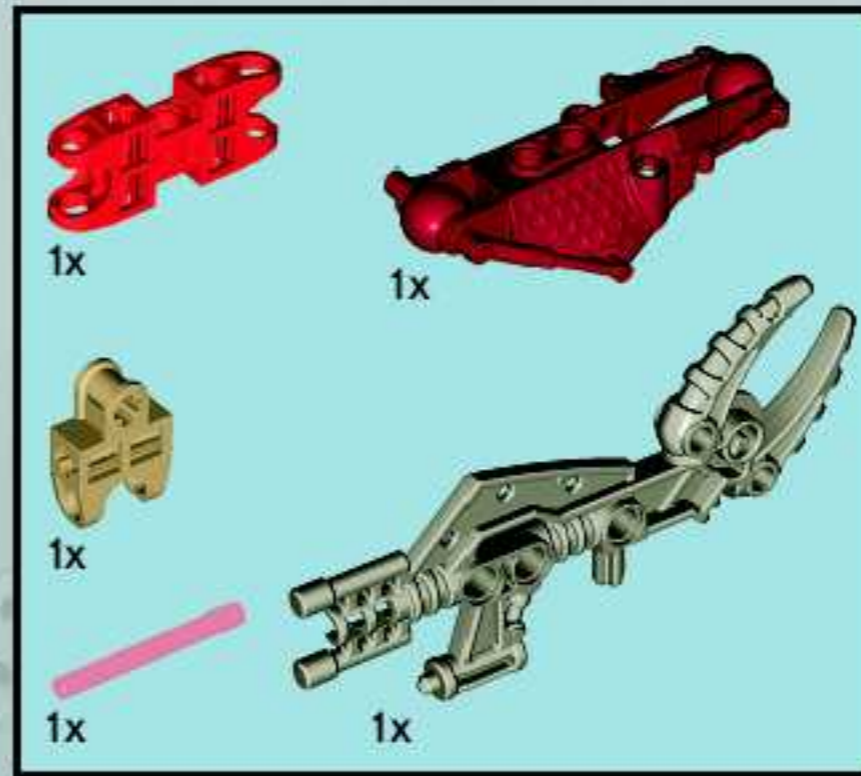

6

1

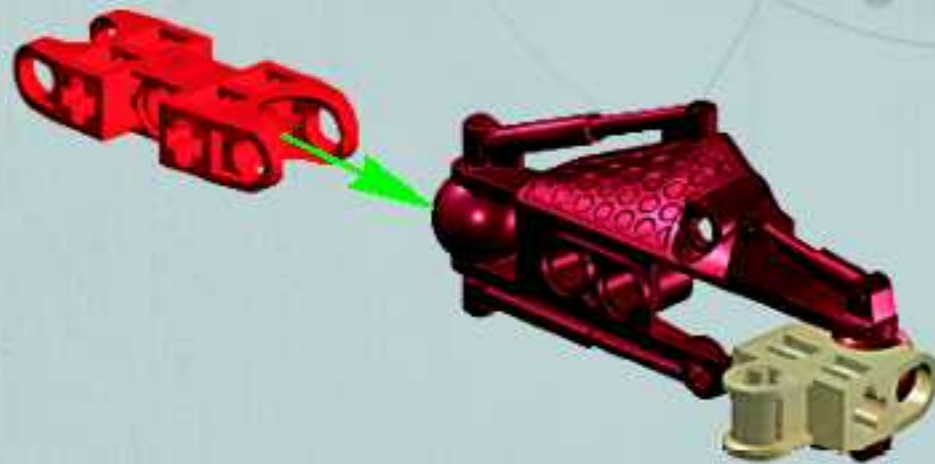

2



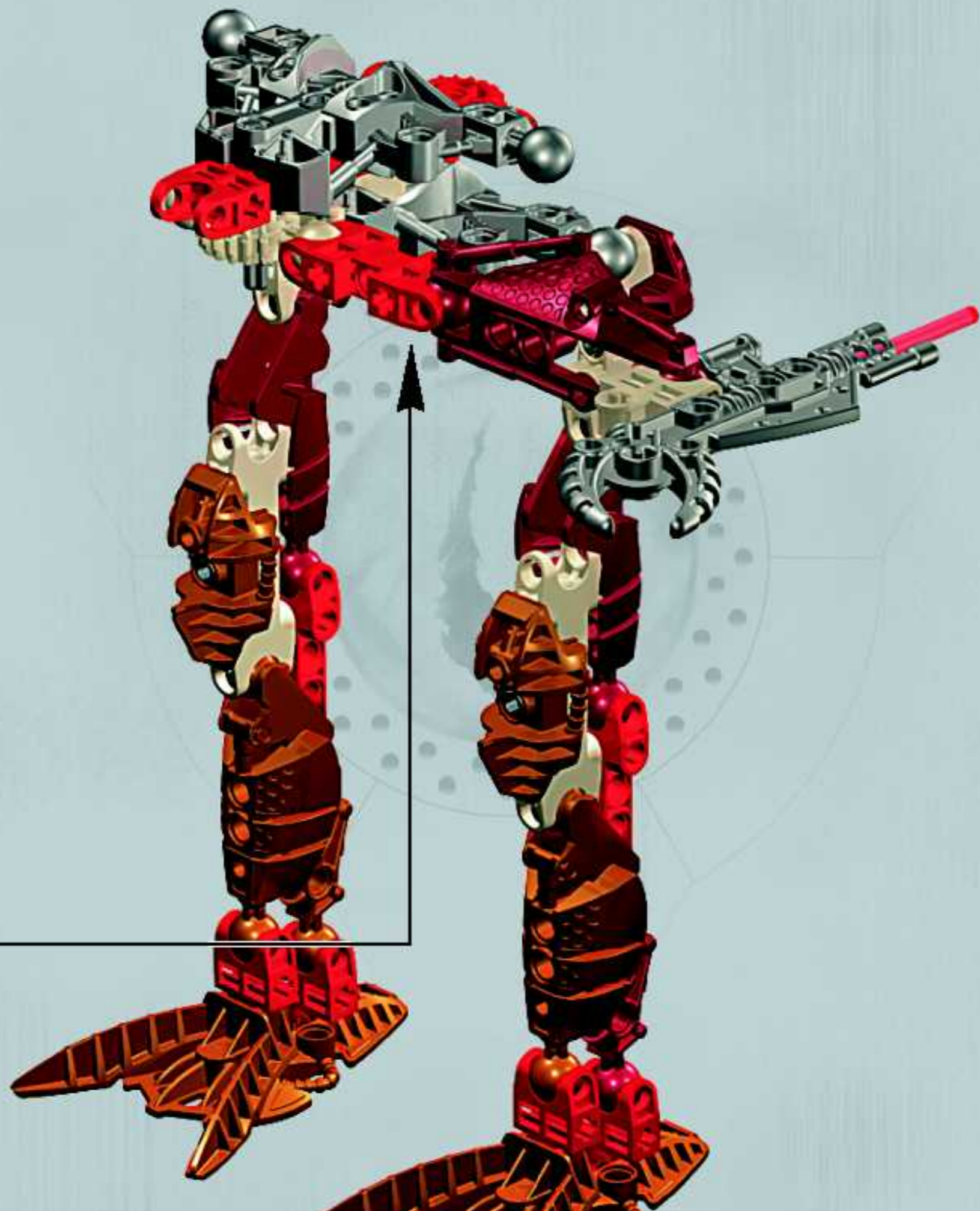

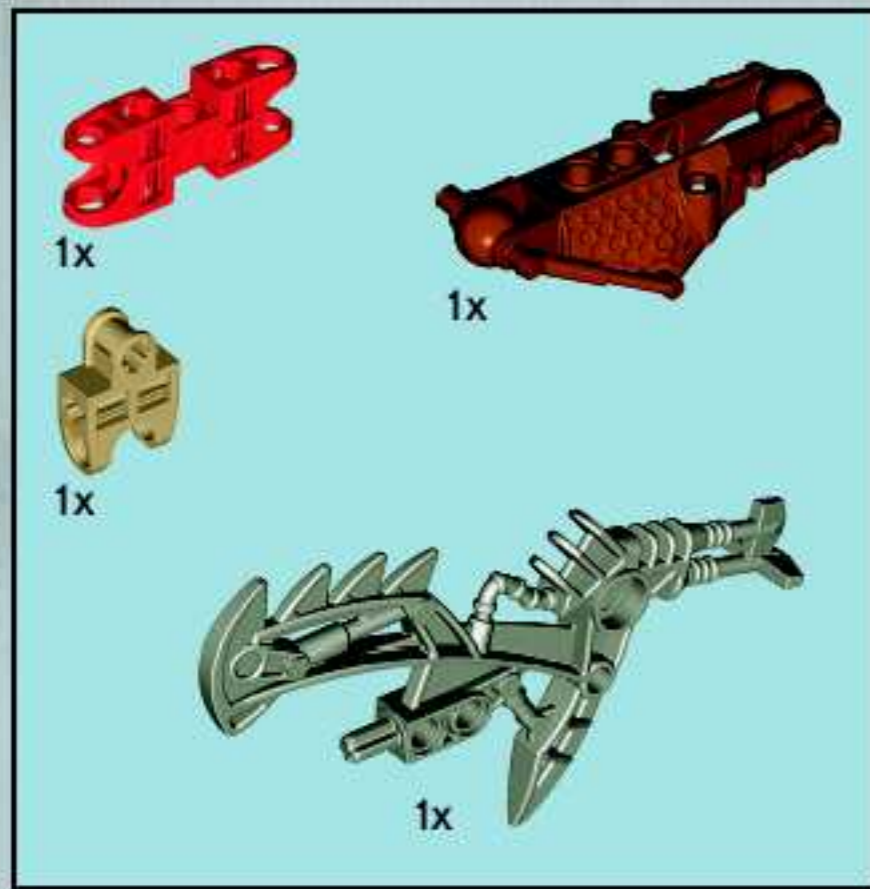

7

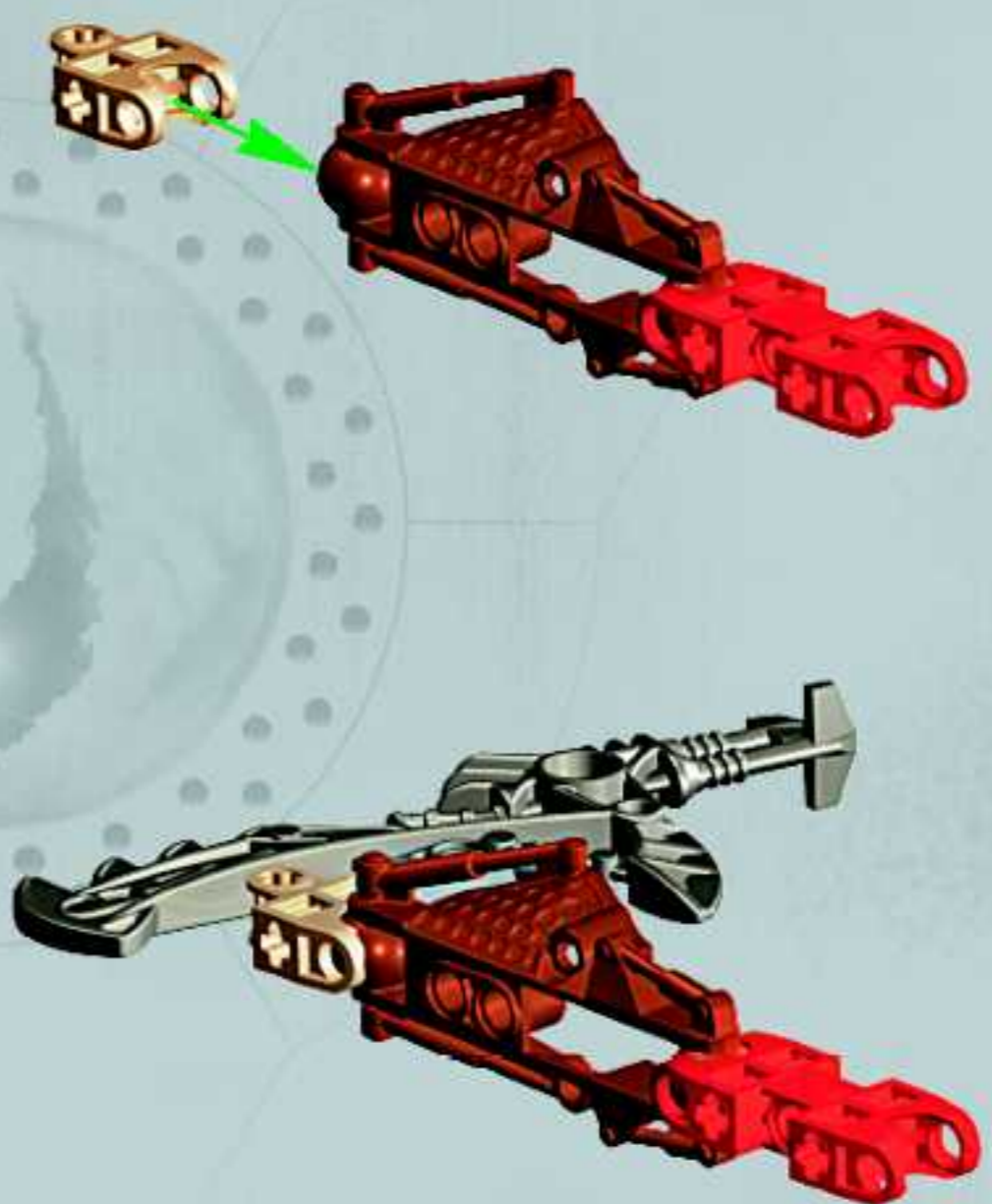



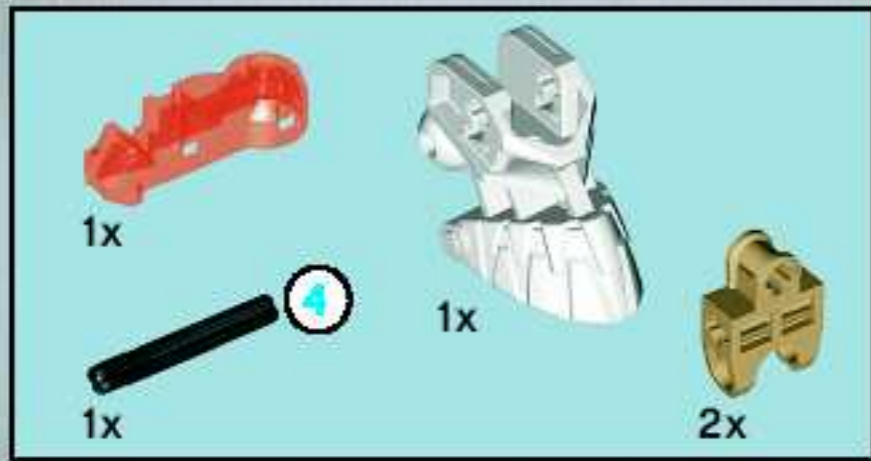

8

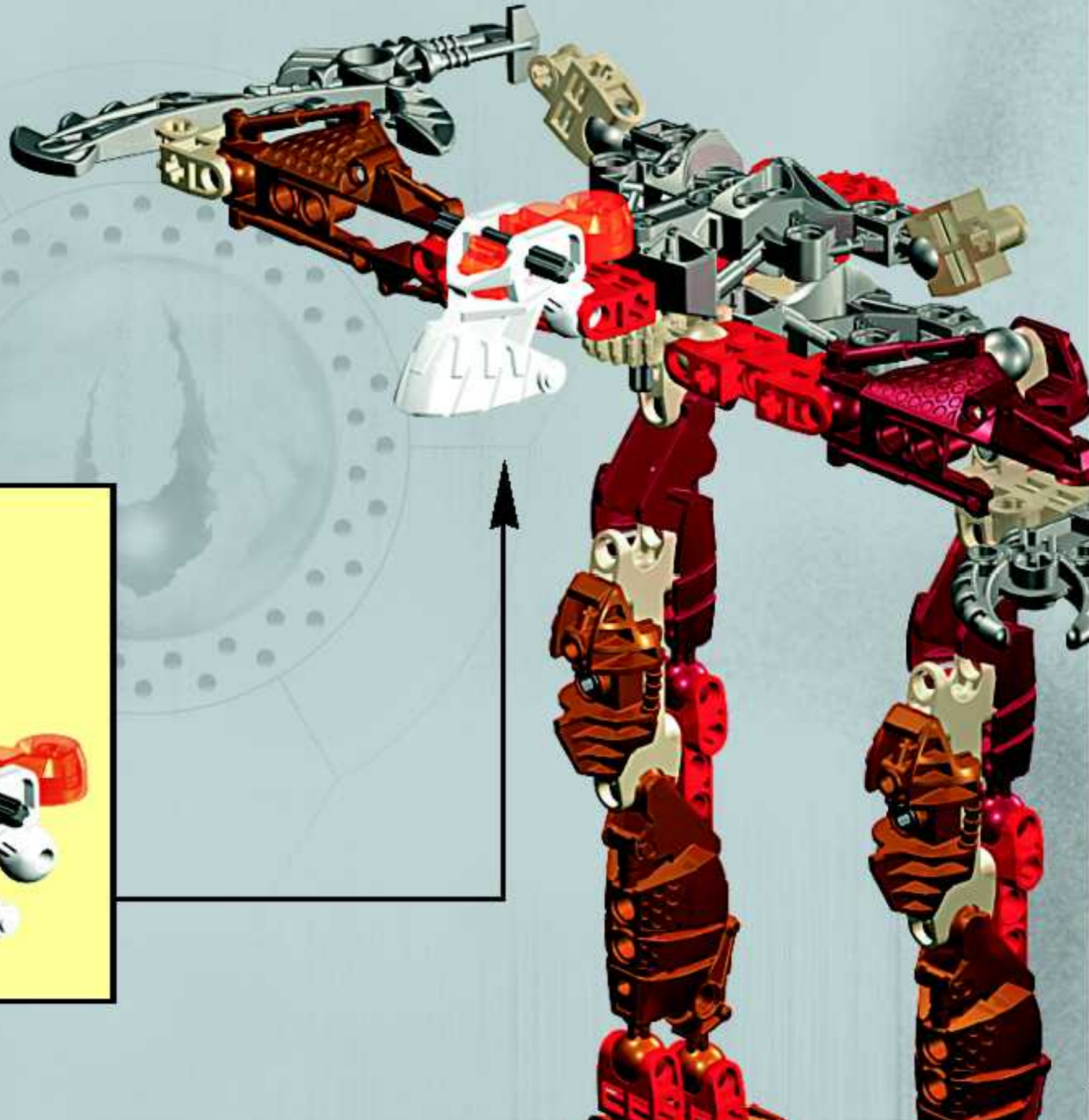
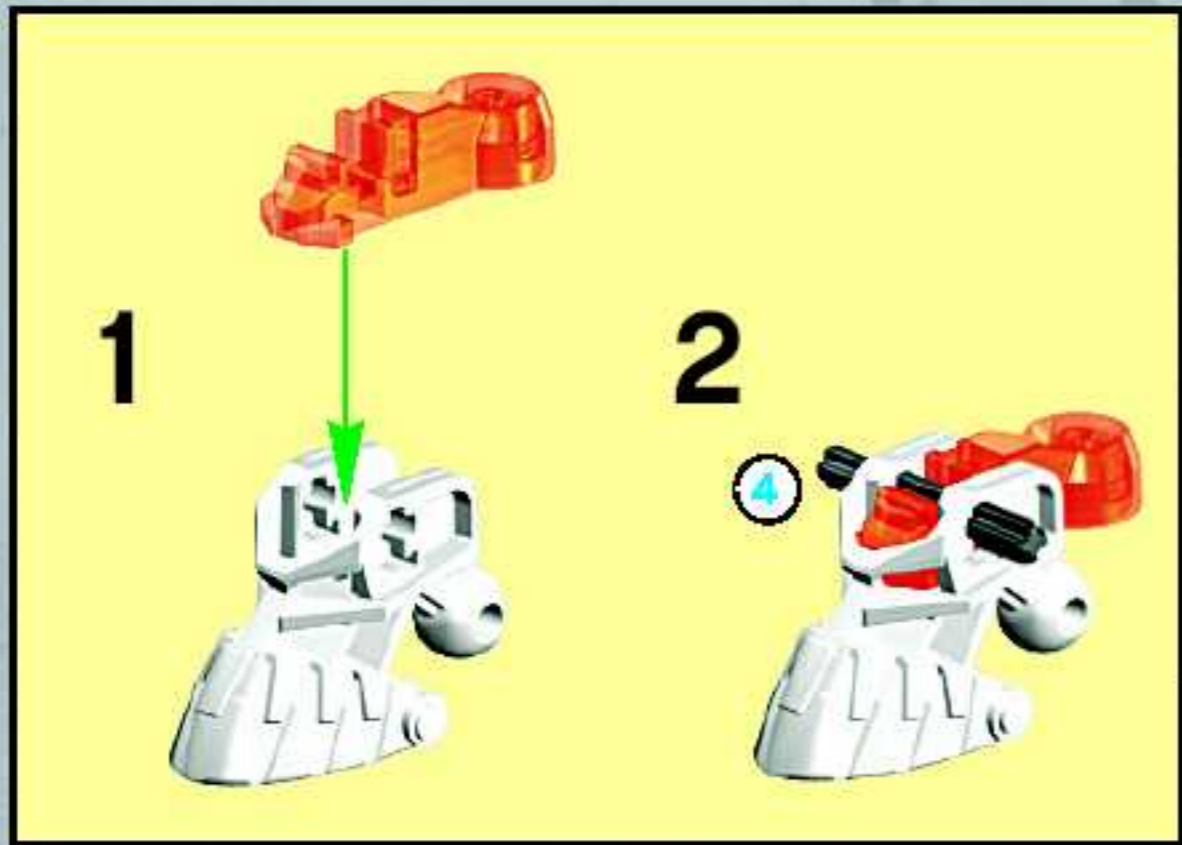

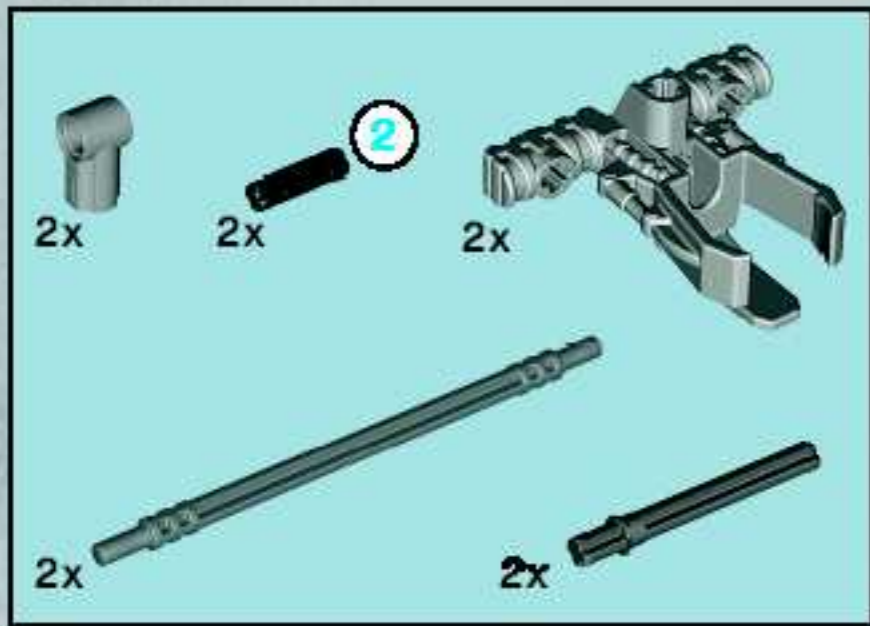

9

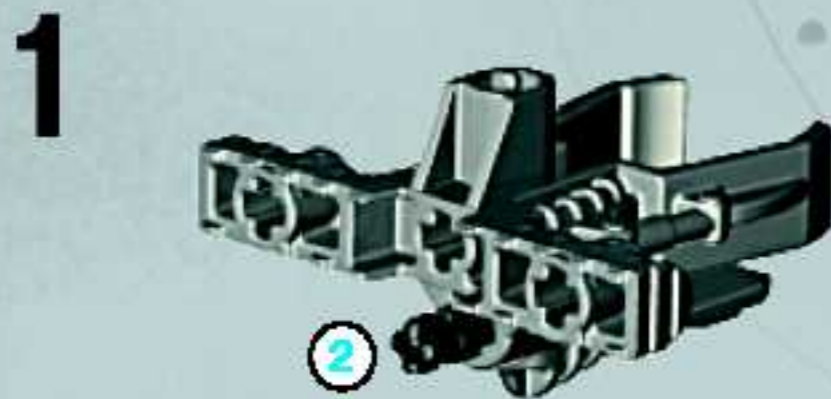
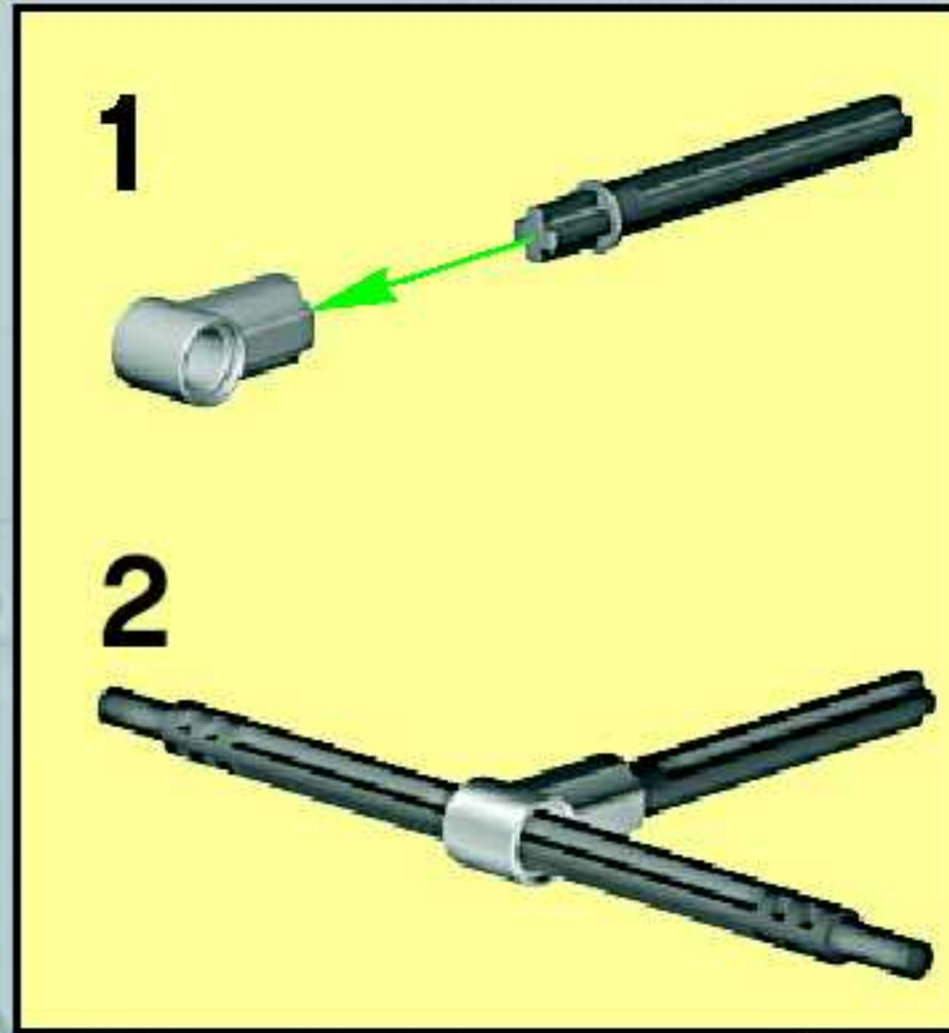

2

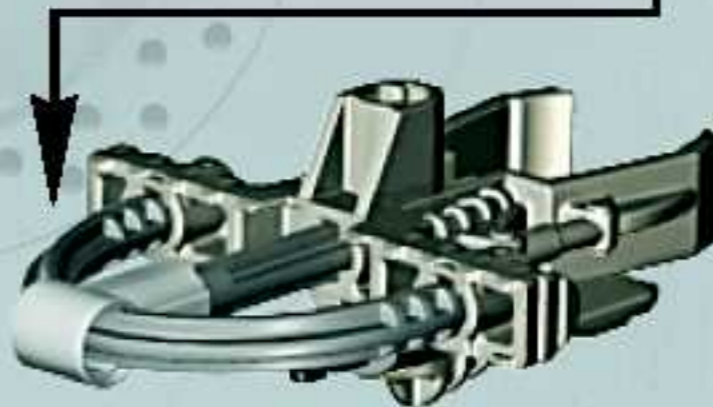

2x

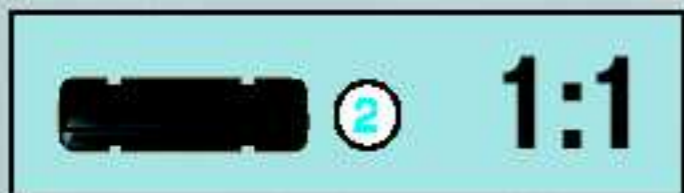



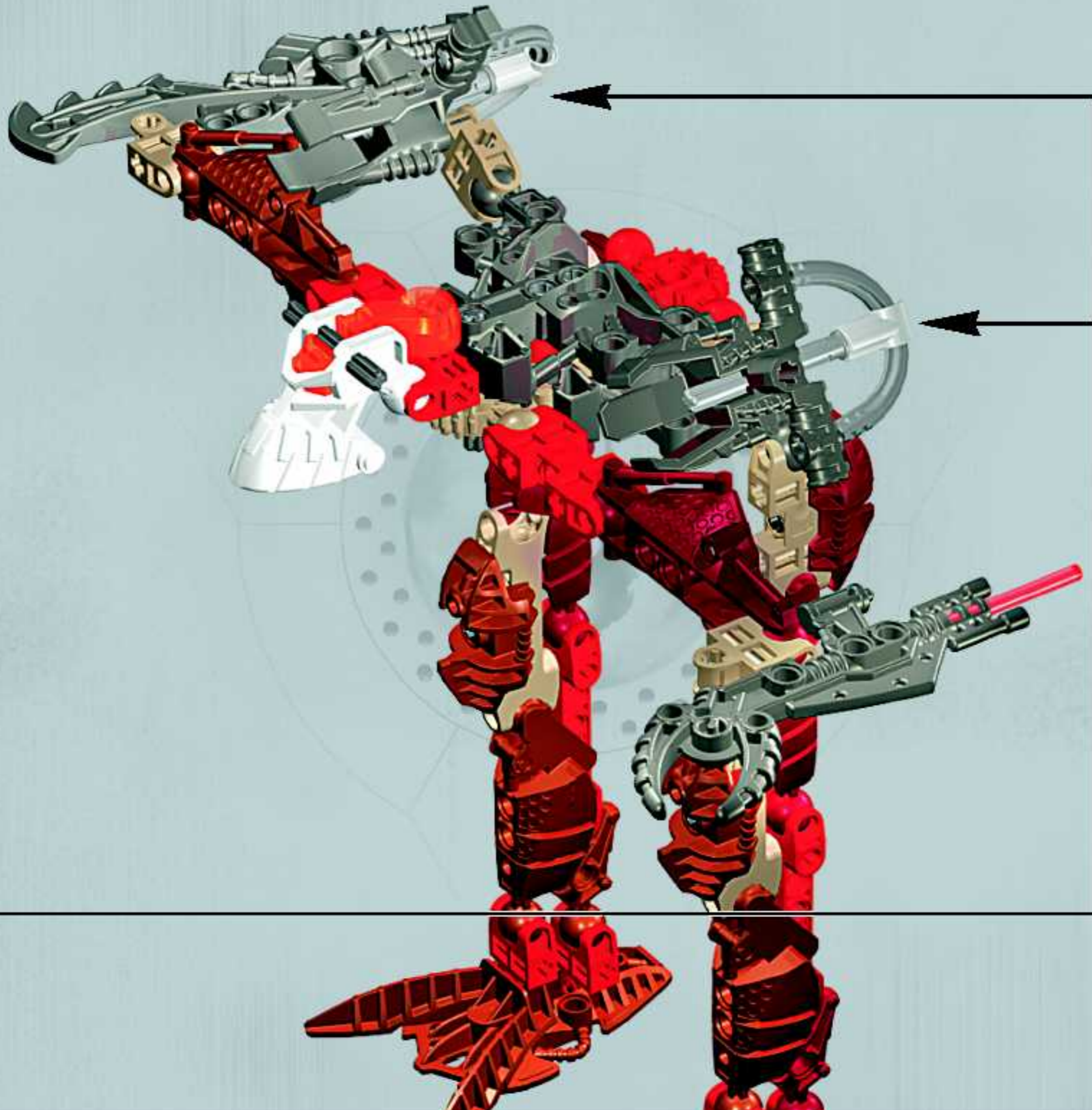



1x  
4290480



1x  
4292000



1x  
4288099



2x  
4287111



1x  
4211550



1x  
4206482



5x  
4287107

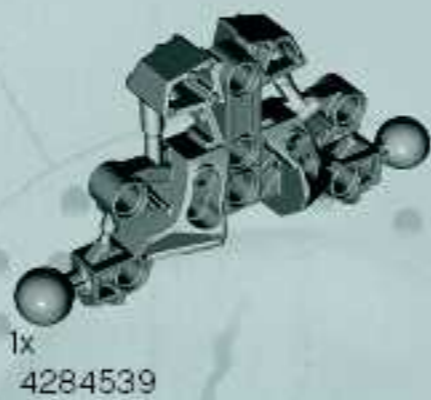

1x  
4284539



1x  
4287109



1x  
4263624



6x  
4121715



1x  
4287106



1x  
4218472



4x  
4296080



1x  
4140801



2x  
4287104



1x  
4288103



2x  
4287110



1x  
4288205



1x  
4109810



2x  
4287105



2x  
4287444

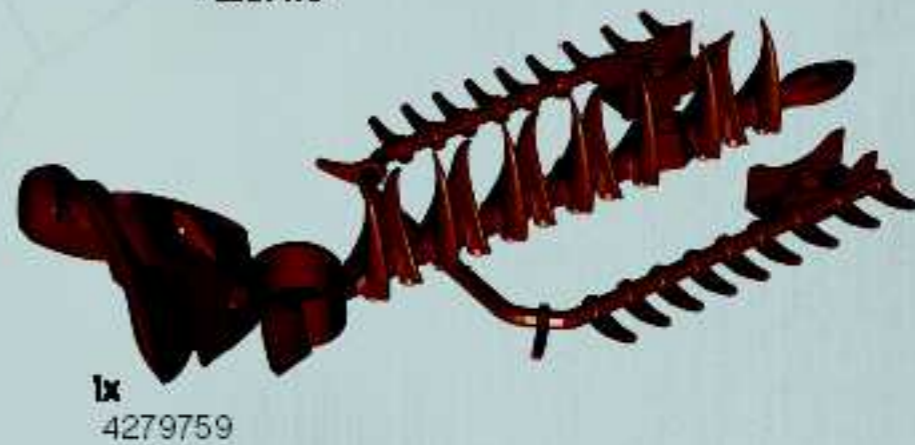

1x  
4279759



1x  
370526

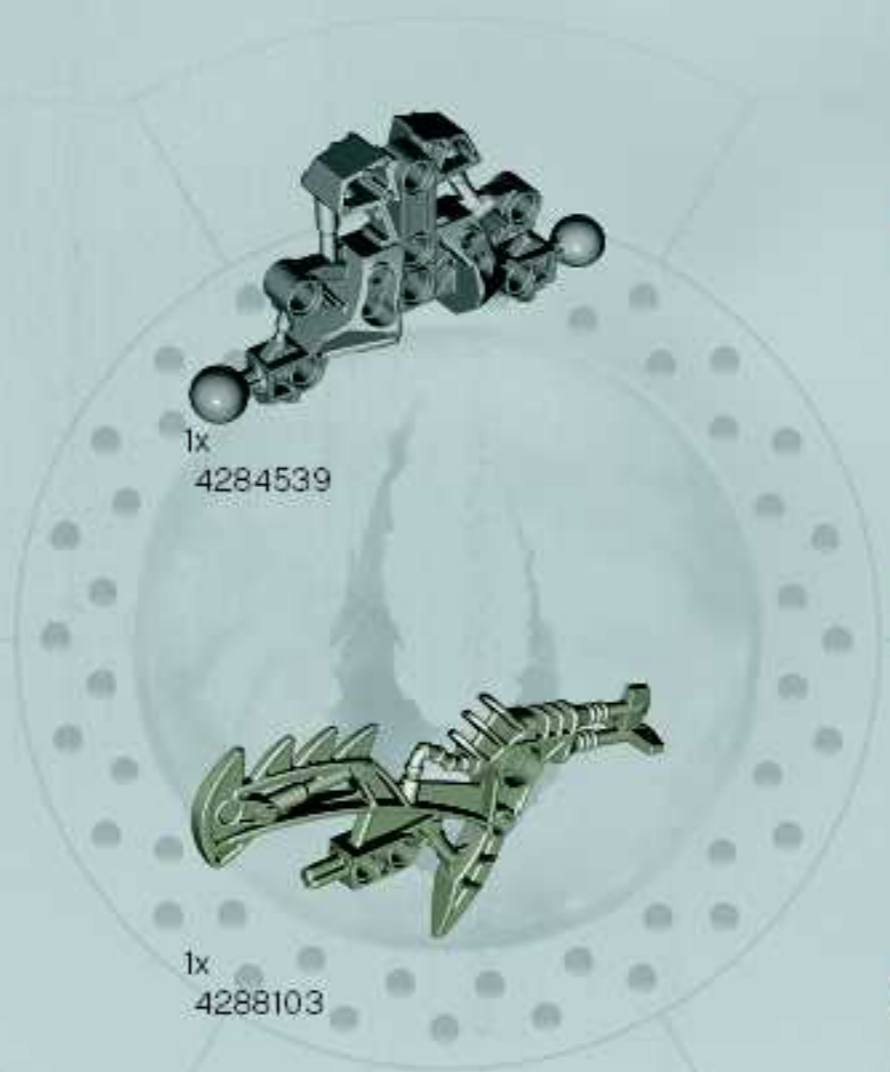



## VOYA NUI



**10 ZAMORS**  
8719



AXONN  
8733



BRUTAKA  
8734

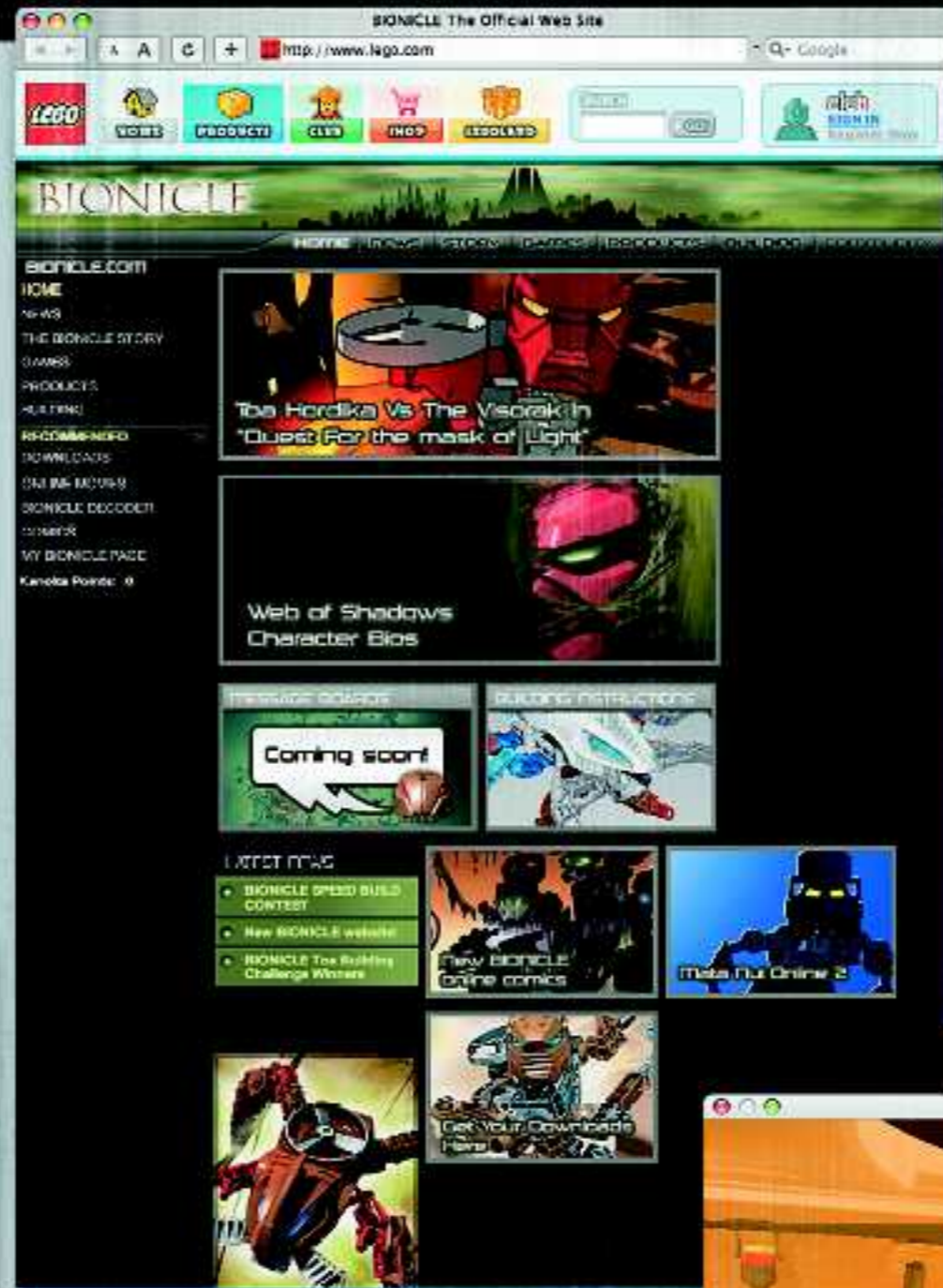

WWW.BIONICLE.COM



# FREE!

Each LEGO Magazine Features...

- Awesome creations by Kids like you!
- Cool Comics & Stories
- Building Tips & Ideas
- Special Offers & Contests to WIN Prizes!

# GRATUIT!

Chaque Magazine LEGO offre...

- Des créations épatantes par des jeunes comme toi!
- Des bandes dessinées et des récits super cool
- Des idées de construction
- Des offres spéciales et des concours pour gagner des prix!

## Join Today!

## Abonne-toi dès aujourd'hui !

# 1-866-534-6258

## www.LEGOclub.com

# Win! Gagne !

### WIN LEGO® PRODUCTS

Log on to [www.acnielsen.aim.dk/LEGO](http://www.acnielsen.aim.dk/LEGO) for further instructions.

### GAGNE DES PRODUITS LEGO

Visite [www.acnielsen.aim.dk/LEGO](http://www.acnielsen.aim.dk/LEGO) pour plus d'informations.

### ESTIMADO USARIO LEGO

Al contestar algunas preguntas en ingles, frances, aleman o japonés en el sitio [www.acnielsen.aim.dk/LEGO](http://www.acnielsen.aim.dk/LEGO), podras participar en el sorteo de algunas valiosos premios LEGO®.

[www.acnielsen.aim.dk/LEGO](http://www.acnielsen.aim.dk/LEGO)



LEGO, the LEGO logo are trademarks of/sont des marques de commerce de/The LEGO Group. ©2005 The LEGO Group.



# SHOP at HOME

## The World's Biggest LEGO® Shop!



For a Free Catalog in the U.S.  
and Canada, call toll-free:

1-866-534-6737

Or go online:

[www.LEGOshop.com/catalog](http://www.LEGOshop.com/catalog)

Pour obtenir un Catalogue GRATUIT  
aux États-Unis et au Canada,  
téléphonez sans frais au :

1-866-534-6737

Ou venez en ligne sur :

[www.LEGOshop.com/catalog](http://www.LEGOshop.com/catalog)



Any questions  
regarding your  
new LEGO  
product, please

contact: Customer

Service | Service

Consommateurs

| Servicio :



1-800-422-5346

or

[www.lego.com/service](http://www.lego.com/service)

